



物聯網智造基地  
I O T S E R V I C E H U B

聯名推動

# CoreMaker

## 實務操作說明

帶你一起進入AIoT的世界

中光電智能感測股份有限公司  
CoretronicMEMS Co., Ltd. (CMC)

主講人：林昆郁 Mars Lin

- 公司簡介
- CoreMaker 介紹
- CoreMaker X TinyML
- CoreMaker 檢查
- 即時偵測與資料擷取
- CoreMaker 開發環境架設
- 開發流程 -- 以 LED 燈效控制為例
- 修改 Sample Rate
- 建立 AI 模型
- AI 資料輸入及結果輸出
- Q & A



# Coretronic MEMS 介紹

# 中光電智能感測 (CoretronicMEMS Corp., CMC)



- ◆ 2013 年成立，2019 年 8 月加入中光電集團
- ◆ 專業 MEMS 感測器 / 模組供應商
  - 無晶圓廠 (Fab-less) MEMS 設計公司
  - 臺灣供應鏈 (晶圓廠/封裝/測試)
  - 專注 “Moving parts” MEMS 技術
- ◆ 核心技術
  - MEMS 設計能力
  - 客制化封裝方案
  - 校正能力
  - 感測器模組 / 子系統

## Sensors

### G-sensor

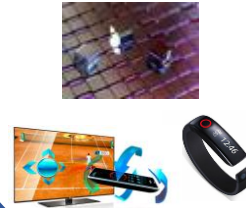

### Pressure Sensor



### Force/Tactile Sensor



## Module

### Sensor+MCU Platform



### PCBA + housing



## Sub-system

### ARM Computing



### AI recognition

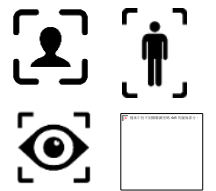

## 胎壓感測芯片



### MEMS sensor

- G-sensor: Z-axis, X/Z-axis
- Pressure sensor: 900kPa/1500kPa

## 水壓/血壓計



- 水壓計: 家電液位檢測
- 血壓計: MEMS die / device

車用前裝級感測器的能力

## Force sensor

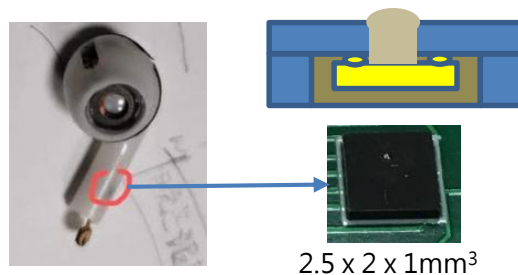

- TWS耳機內建force.
- 專利取得 台灣/美國

## Pressure sensor



- Relative accuracy: <1pa (10cm)
- Absolute pressure

技術延伸擴大應用

## 光學MEMS應用

### LiDAR

#### Mirror

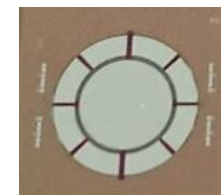

#### Driver Board



### DS/SP

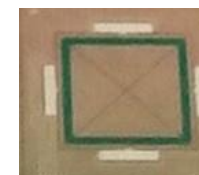

發展壓電通用平台技術, 長期技術核心

# 工業級感測模組

薄膜壓電無Zero-g drift問題 · 高精度  
低成本優勢

整合MCU模組化：  
客戶domain knowhow可植入模組內

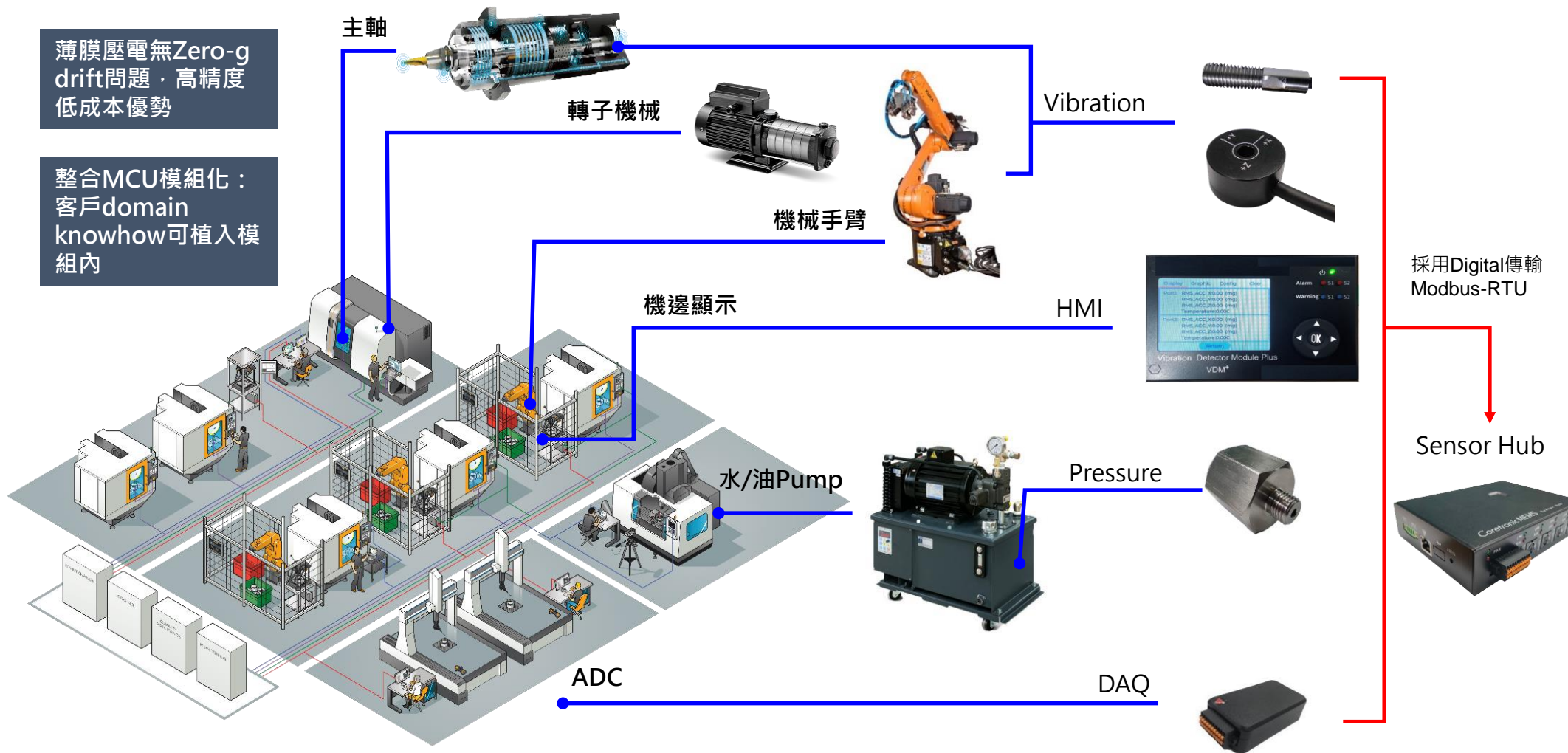

# CoreMaker 介紹



# 以 Device AI 概念打造高性價比 AIoT 方案

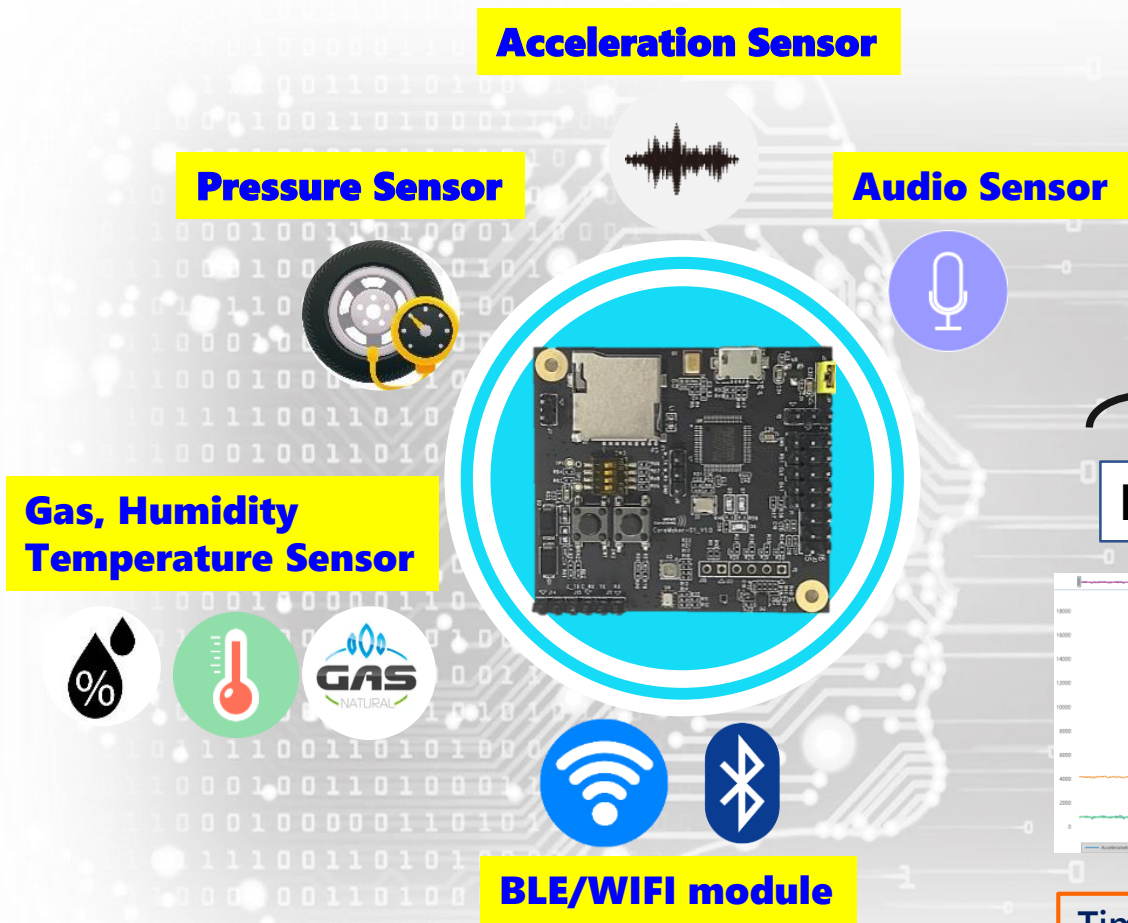

## ◆ 演算法開發

- ❑ 客戶自行開發或委託 CMC 專案開發
- ❑ 整合式平台快速進行監督式機器學習
- ❑ 完成後再將 AI 模型燒錄到 HW

## ML Web-based tools

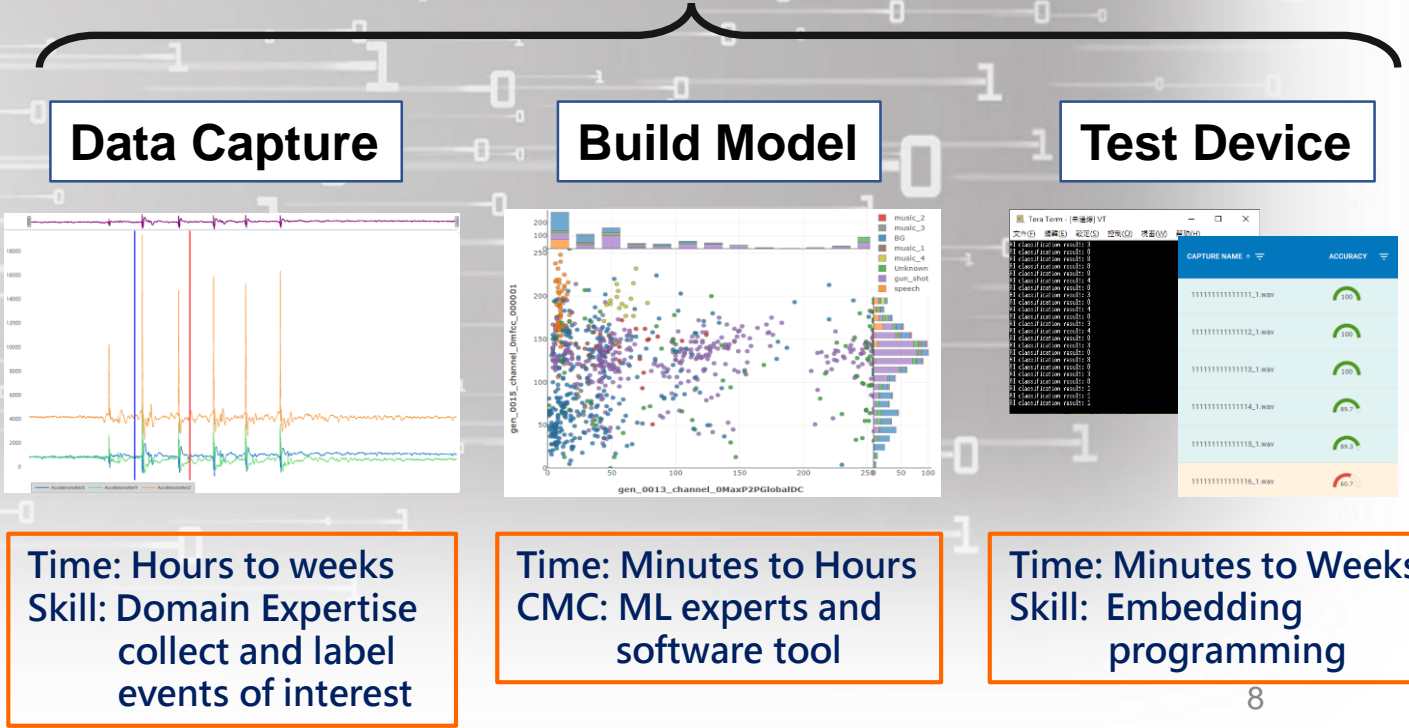



# HDK Features

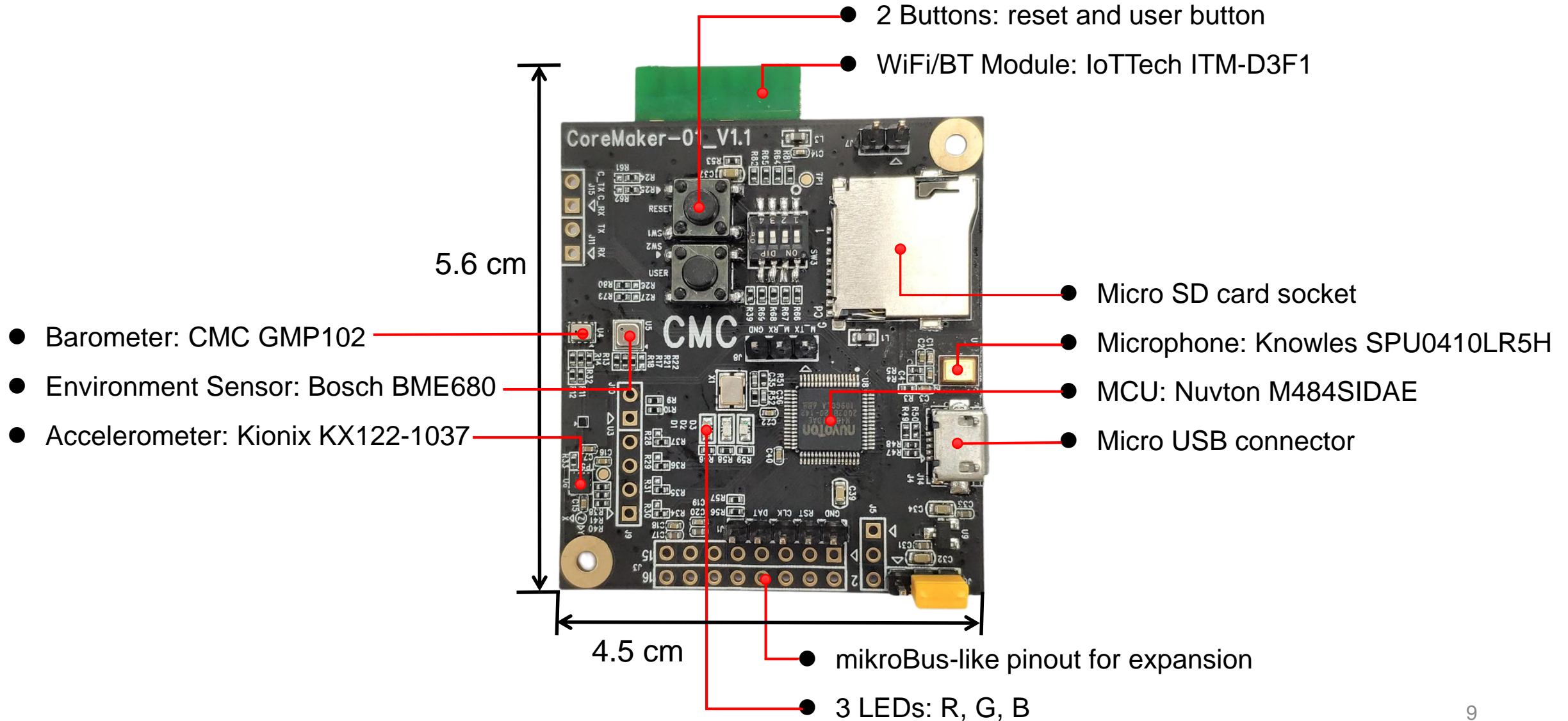

# BSP Features

- ARM Mbed OS
- All on-board sensor drivers
- Wi/BT and SD-Card drivers
- Support AI integration : Simple Streaming Interface for Data Capture
- Demo cases and example code

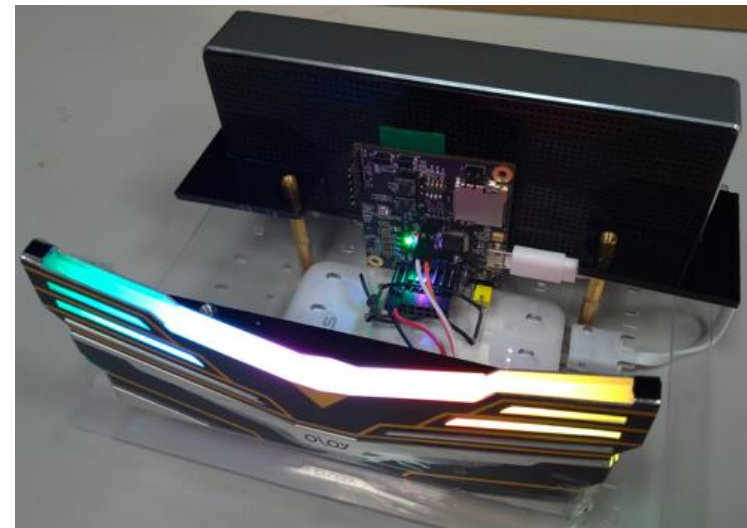

[Audio Detection Demo](#)

# CoreMaker 使用方式

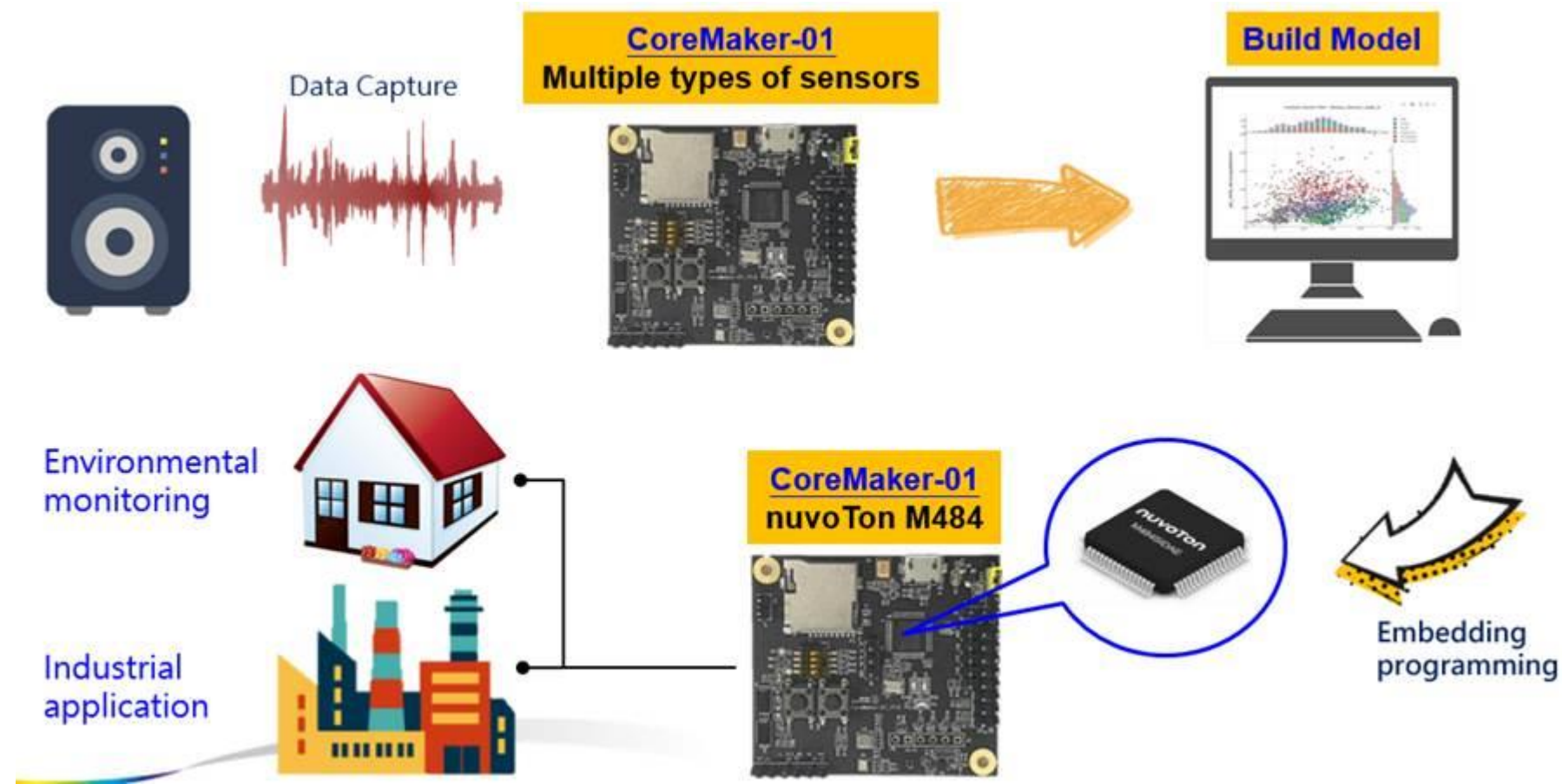

# Why CoreMaker?

## 資料多元 & 方便上手

內建 4 種感測器，可以蒐集包含加速度、聲音、溫度、濕度、氣壓、空氣品質等 6 種資訊。拿到即可開始蒐集資料，無須修改程式。



## 無線傳輸

內建 WiFi 與藍芽 5.0 模組，可進行遠端資料蒐集，傳輸距離最遠可達 300 公尺，避免長距離傳送架設線材的額外花費。

## 快速開發

提供詳細的說明文件及範例程式，簡化程式編譯與燒錄步驟，加速開發流程。

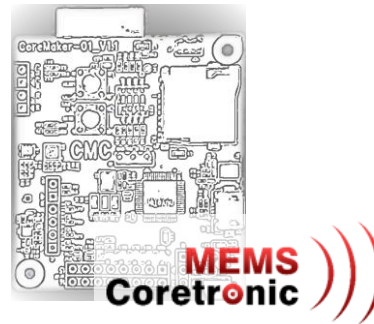

## 本地儲存

內建 SD card 儲存模組，感測資料隨收隨存，滿足獨立運作的條件，讓應用不再被環境限制。

## AI 輕鬆佈署

搭配 TinyML 工具，使用圖形化、模組化的開發介面，降低開發門檻，僅需 4 個步驟就可以建立 AI 模型。



## 高效能低功耗

使用以 Arm® Cortex®-M4F 為核心的新唐 M484 微處理器，時脈最高可到 192 MHz，動態運作下的功耗僅 175  $\mu$ A/MHz，待機狀態下可以低於 1  $\mu$ A。



# CoreMaker X TinyML

TinyML: Tiny Machine Learning

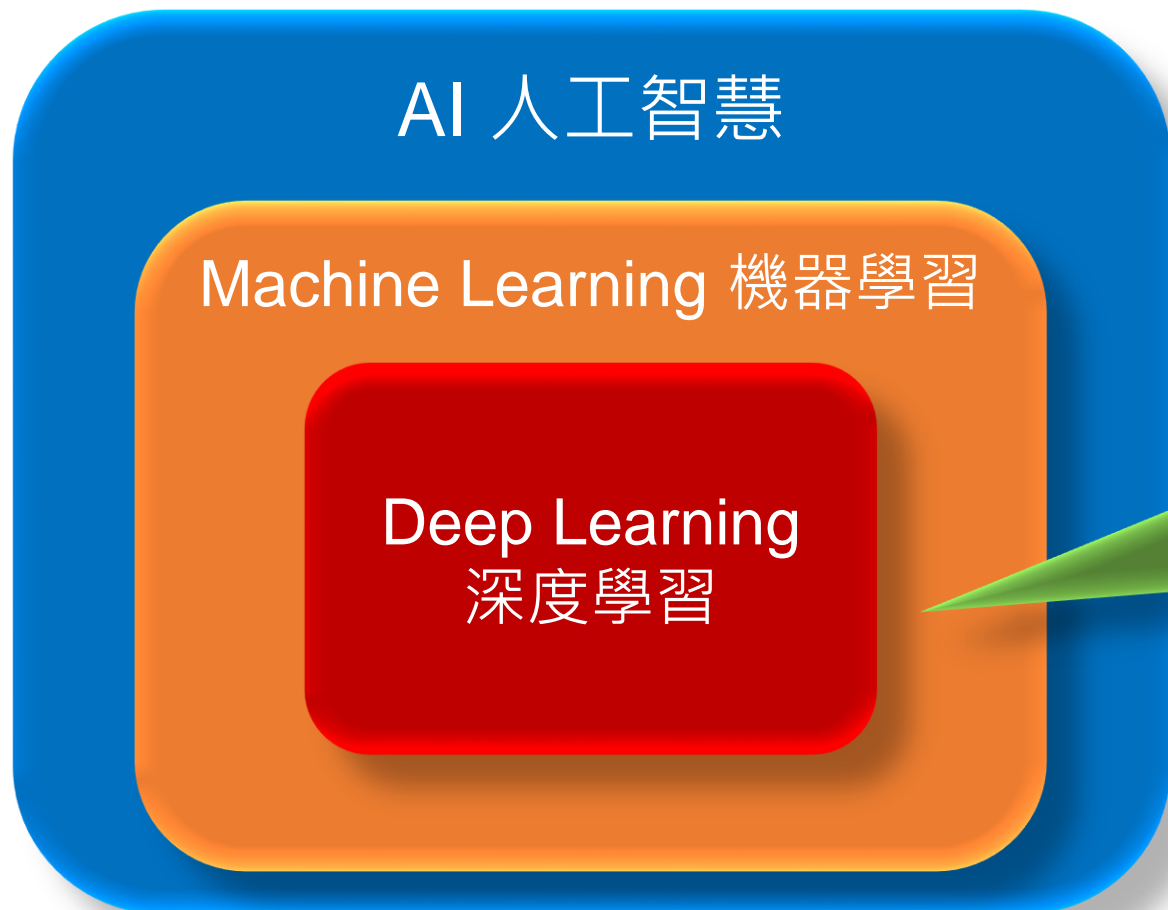

- 監督式學習 SensiML重點
- 非監督式學習
- 半監督式學習
- 增強學習 獎勵回饋方式

重點: 分類、回歸、聚類



# TinyML 介紹

- TinyML 是一種輕量型 AI 開發的技術
- 概念上與 Edge AI 相似，能夠快速取得推論結果，節省資料傳輸的花費，同時提高資料安全性
- 實現的對象為微控制器 (MCU)，因此在運算力需求上更為低廉

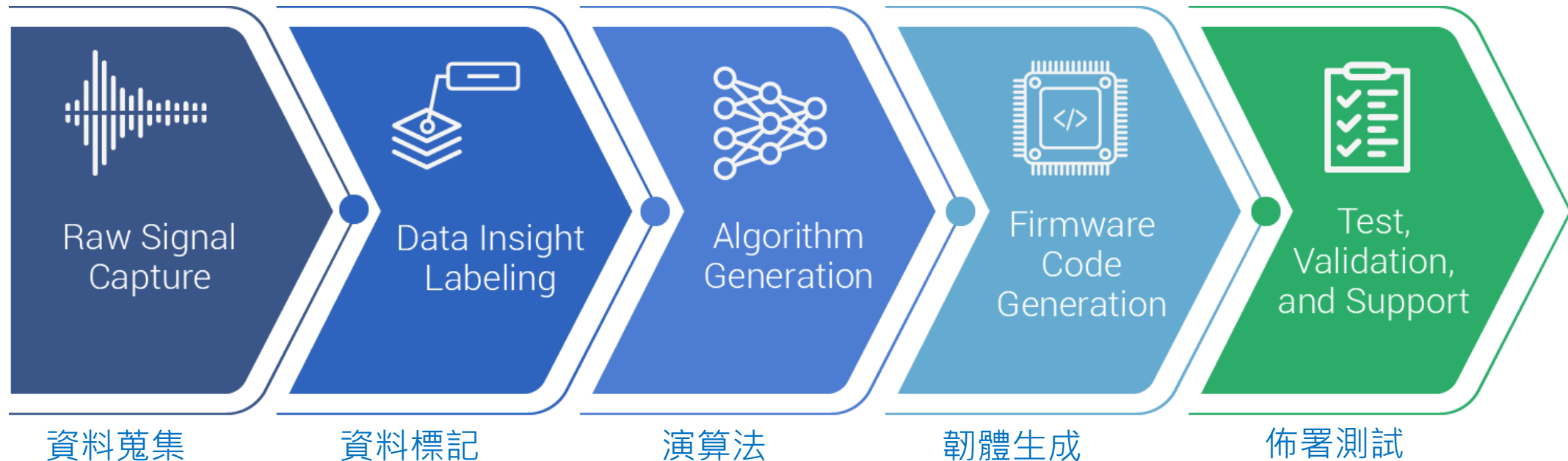

◆ Edge AI定義: 在端點(Local)完成計算，不需傳出

# AI平台: SensiML & Edge Impulse

Project: fan\_01\_20220701

MODEL VISUALIZATION **CONFUSION MATRIX** FEATURE SUMMARY MODEL SUMMARY PIPELINE SUMMARY

### Average across all validation folds

	Unknown	high	low	off	rock	stick	UNK	Support	Sense %
Unknown	0	0	1	0	0	0	0	1.00	0
high	0	3	0	0	0	0	0	3.00	100.00
low	0	0	3	0	0	0	0	3.00	100.00
off	0	0	0	3	0	0	0	3.00	100.00
rock	0	0	0	0	3	0	0	3.00	100.00
stick	0	0	0	0	0	4	0	4.00	100.00
Total	0	3.00	4.00	3.00	3.00	4.00	0	17.00	
Pos_Pred(%)		100.00	75.00	100.00	100.00	100.00		Acc(%)	94.12

Full training data (final model with recall)

- Project Summary
- Prepare Data
- Build Model
- Explore Model
- Test Model
- Download Model
- Get Started
- Demo
- Documentation
- Support

SensiML

EDGE IMPULSE Product Solutions Developers Pricing Company Blog Login **Get started**

Collect: Acquire valuable data securely and rapidly build datasets

Design

Test

Deploy

DATA ACQUISITION (ANOMALY DETECTION)

Training data | Test data | Export data

DATA COLLECTED: 10m 45s

TRAIN / TEST SPLIT: 79% / 21%

Record new data

Device ID: My device

Label: Mode 1

Sample length (ms): 9000

Sensor: Built-in accelerometer

Frequency: 100Hz

Start sampling

SAMPLE NAME	LABEL	ASSET	LENGTH
Mode 1.2nebr80.s3	Mode 1	Today, 20:20:10	3s
Mode 1.2nebr80.s2	Mode 1	Today, 20:20:10	3s
Mode 1.2nebr80.s1	Mode 1	Today, 20:26:10	3s
Mode 1.2nebr80.s25	Mode 2	Today, 19:43:55	3s
Mode 1.2nebr80.s24	Mode 2	Today, 19:43:55	3s
Mode 1.2nebr80.s23	Mode 2	Today, 19:43:55	3s
Mode 1.2nebr80.s22	Mode 2	Today, 19:43:55	3s
Mode 1.2nebr80.s21	Mode 2	Today, 19:43:55	3s
Mode 1.2nebr80.s20	Mode 2	Today, 19:43:55	3s
Mode 1.2nebr80.s17	Mode 2	Today, 19:43:55	3s
Mode 1.2nebr80.s16	Mode 2	Today, 19:43:55	3s
Mode 1.2nebr80.s14	Mode 2	Today, 19:43:55	3s

RAW DATA: Mode 1.2nebr80.s22

Edge Impulse

# TinyML 整合型開發平台

- 目前已有各家廠商推出 TinyML 整合型開發平台，提供圖形化介面、無程式碼 (No-Code) 或少程式碼 (Low-Code) 的解決方案，使用者能夠直觀且快速的操作模型建構流程

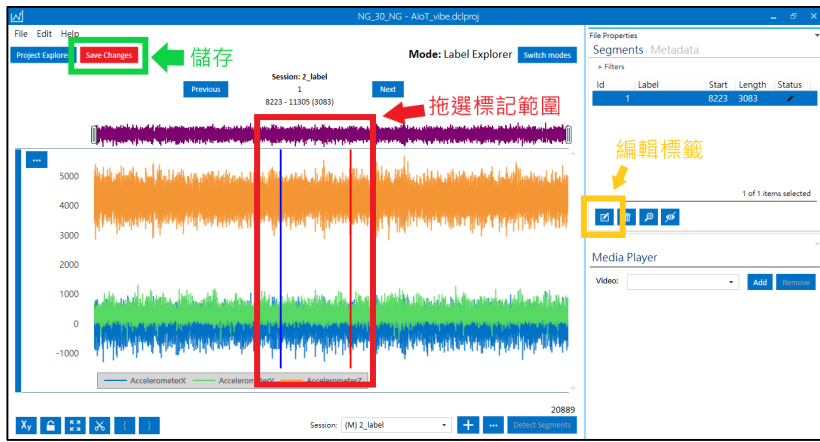

資料擷取、標記

## 模型訓練

Workflow diagram showing the training process:

- Name: AIoT\_vibe, Type: Input Query
- Name: Windowing, Type: Segmenter
- Type: AutoML Parameters
- Classifier SRAM: 32000
- f1-score: 100
- OPTIMIZE button

MODEL NAME	ACCURACY	CLASSIFIER SIZE(B)	NUM. FEATURES	SENSITIVITY	F1-SCORE
fixed_window_size_rank_0	63	3049	24	61	63
fixed_window_size_rank_1	66	2149	12	62	62
fixed_window_size_rank_2	69	1849	8	60	61
fixed_window_size_rank_3	65	3274	27	58	60
fixed_window_size_rank_4	64	1340	4	55	58



線上測試

# 使用 CoreMake 蒐集資料

- CoreMaker 搭配 TinyML 整合型開發平台的資料擷取功能，可以輕鬆開始蒐集多樣的資料

### Select a Device Plugin

The Data Capture Lab comes with plugins for the following devices. You can import your own plugin for any third-party device by following the instructions in the [Creating a Device Plugin documentation](#)

Source	Manufacturer	Device	Plugin Developer	Capture Protocol	Available Sensors
CoretronicMEMS	CoretronicMEMS	CoreMaker-01	CoretronicMEMS	Simple Streaming	Microphone, Environment, Motion, Compass
Arduino	Arduino	Nano33 BLE Sense	SensiML	Simple Streaming	Microphone, Environment, Motion, Compass
Infinion	Infinion	PSoC 6 Wi-Fi BT Pioneer Kit	SensiML	Simple Streaming	Microphone, Environment, Motion, Compass
Microchip Technology	Microchip Technology	SAMD21 ML Eval Kit	Microchip Technology	Simple Streaming	Microphone, Environment, Motion, Compass
Nordic Semiconductor	Nordic Semiconductor	Thingy:52	SensiML	Custom	Microphone, Environment, Motion, Compass
onsemi	onsemi	RSL10 Sense	onsemi	Simple Streaming	Microphone, Environment, Motion, Compass
QuickLogic	QuickLogic	Chilkat	QuickLogic	Custom	Microphone, Environment, Motion, Compass
QuickLogic	QuickLogic	QuickAI	QuickLogic	Custom	Microphone, Environment, Motion, Compass
QuickLogic	QuickLogic	QuickAI	QuickLogic	MQTT-SN	Microphone, Environment, Motion, Compass
QuickLogic	QuickLogic	QuickFeather	QuickLogic	MQTT-SN	Microphone, Environment, Motion, Compass
QuickLogic	QuickLogic	QuickFeather	QuickLogic	Simple Streaming	Microphone, Environment, Motion, Compass

Cancel Next

### Plugin Details

Manufacturer: CoretronicMEMS  
Plugin Developer: CoretronicMEMS  
Capture Protocol: Simple Streaming  
Firmware Download: [Data Collection Firmware](#)  
Sensor Summary:  
Name: Audio  
Sensors: Microphone  
Sample Rates: 16000, 8000, 4000, 2000, 1000, 400, 200, 100  
Name: Environment  
Sensors: Temperature, Pressure, Humidity, Gas resistance  
Sample Rates: 1  
Name: Motion  
Sensors: Accelerometer  
Sample Rates: 12800, 6400, 3200, 1600, 800, 400, 200, 100, 50, 25  
Name: Compass  
Sensors: Magnet  
Sample Rates: 200, 100, 50, 20, 10

Back Next

### Sensor Properties

Device Plugin: CoreMaker-01  
Capture Source: Audio  
Sample Rate: 2000  
Selected Sensors:  Microphone

Back Next

# CoreMaker 検査

# 檢查項目 (1) -- LED 燈號

- 正常
  - 上電後紅色 LED 燈會閃爍，呈現呼吸燈效
- 異常
  - LED 燈不會亮
  - 藍色或綠色 LED 燈亮

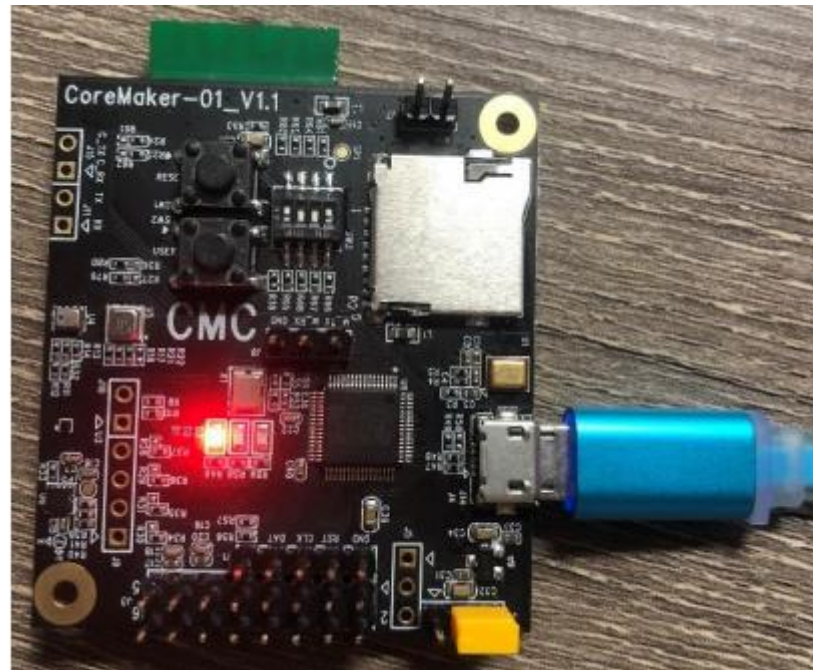



# 檢查項目 (2) -- 輸出訊息

- 使用 UART to USB 轉接線，連接 CoreMaker J8 區針腳
- 使用 Micro USB to USB 轉接線，連接供電裝置 (PC、行動電源等) 提供 CoreMaker 電力
- 連接方式
  - UART GND -> CoreMaker GND
  - UART TX -> CoreMaker M\_RX
  - UART RX -> CoreMaker M\_TX

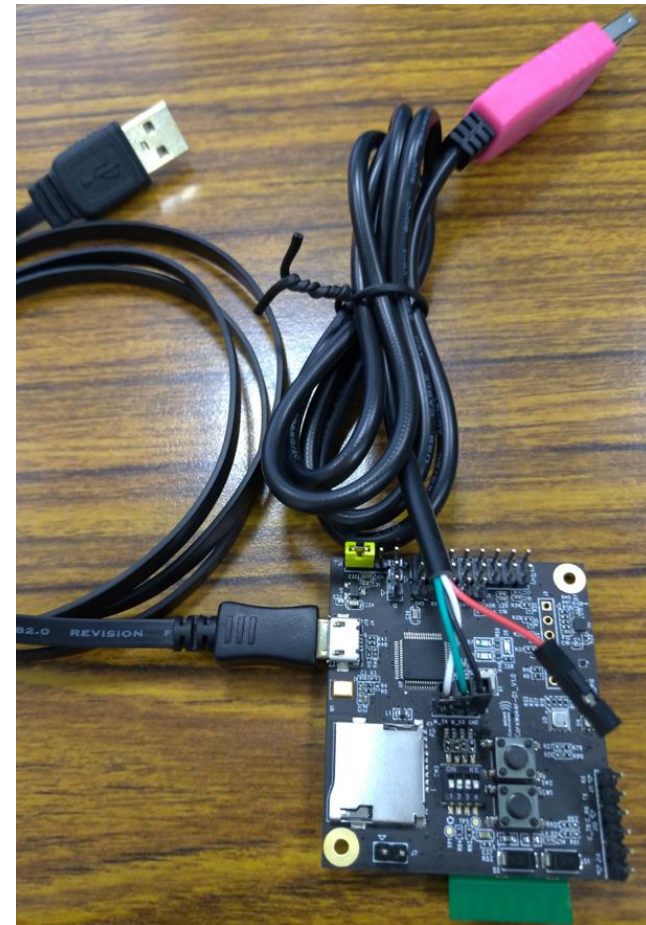

# 檢查項目 (2) -- 輸出訊息

- 開啟連線程式，如 [Tera Term](#)<sup>1</sup> (Windows)、[串口調試助手](#)<sup>2</sup> (Windows)、[Minicom](#) (Linux) 等，以下將以 Tera Term 作為範例

## 1. 選擇連接埠



## 2. 設定 Baud Rate 為 115200

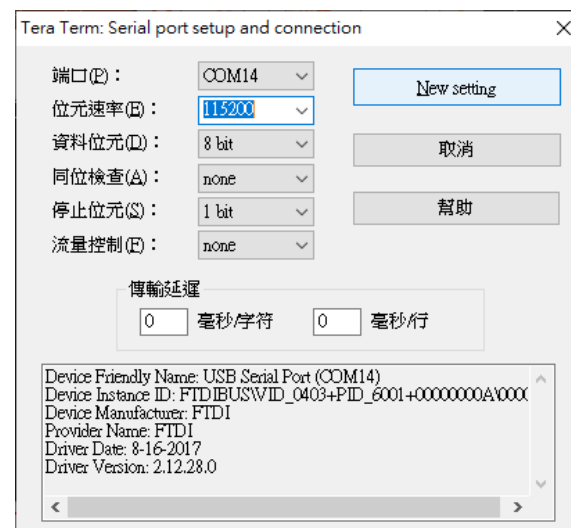
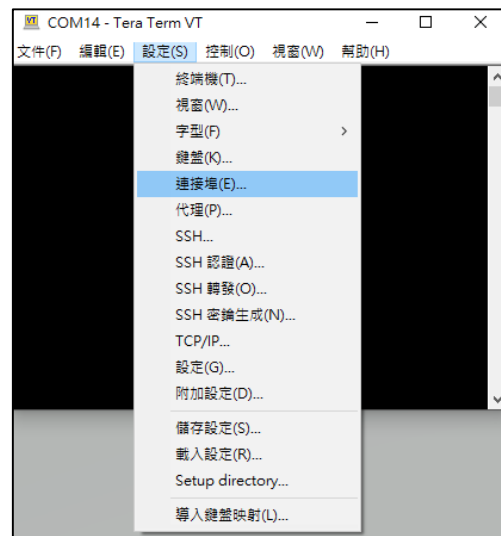

1. <https://osdn.net/projects/ttssh2/releases/>

2. <https://www.microsoft.com/zh-tw/p/%E4%B8%B2%E5%8F%A3%E8%AA%BF%E8%A9%A6%E5%8A%A9%E6%89%8B/9nblggh43hdm#activetab=pivot:overviewtab>

# 檢查項目 (2) -- 輸出訊息

3. 設定完成後，按下 CoreMaker 上的 Reset 鍵 (SW1)，可以看到 CoreMaker 的開機訊息，訊息內容包含 Mbed OS 版本號及 sensor 的初始化訊息

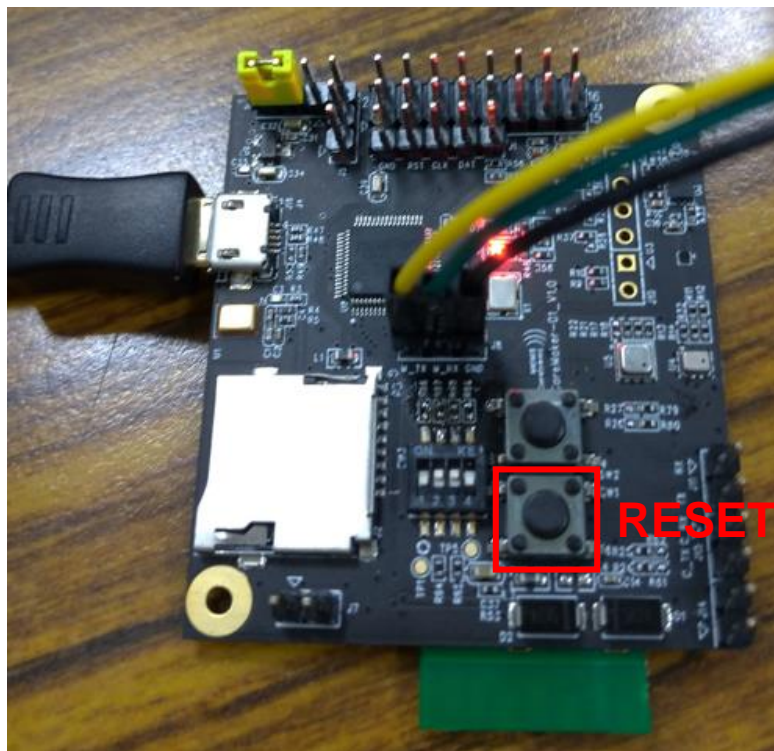

```
COM14 - Tera Term VT
文件(F) 編輯(E) 設定(S) 控制(O) 視窗(W) 幫助(H)

Mbed OS version - 6.15.0
spu0410 initialized
bme680 initialized
kx122 initialized
gmc306 initialized
gmp102 initialized
```

# 即時偵測與資料擷取

SensiML 資料蒐集使用簡介

# 安裝資料擷取工具

- 進入 SensiML 網站的 Downloads 頁面 <https://sensiml.com/download/>，下載 SensiML Data Capture Lab 並安裝

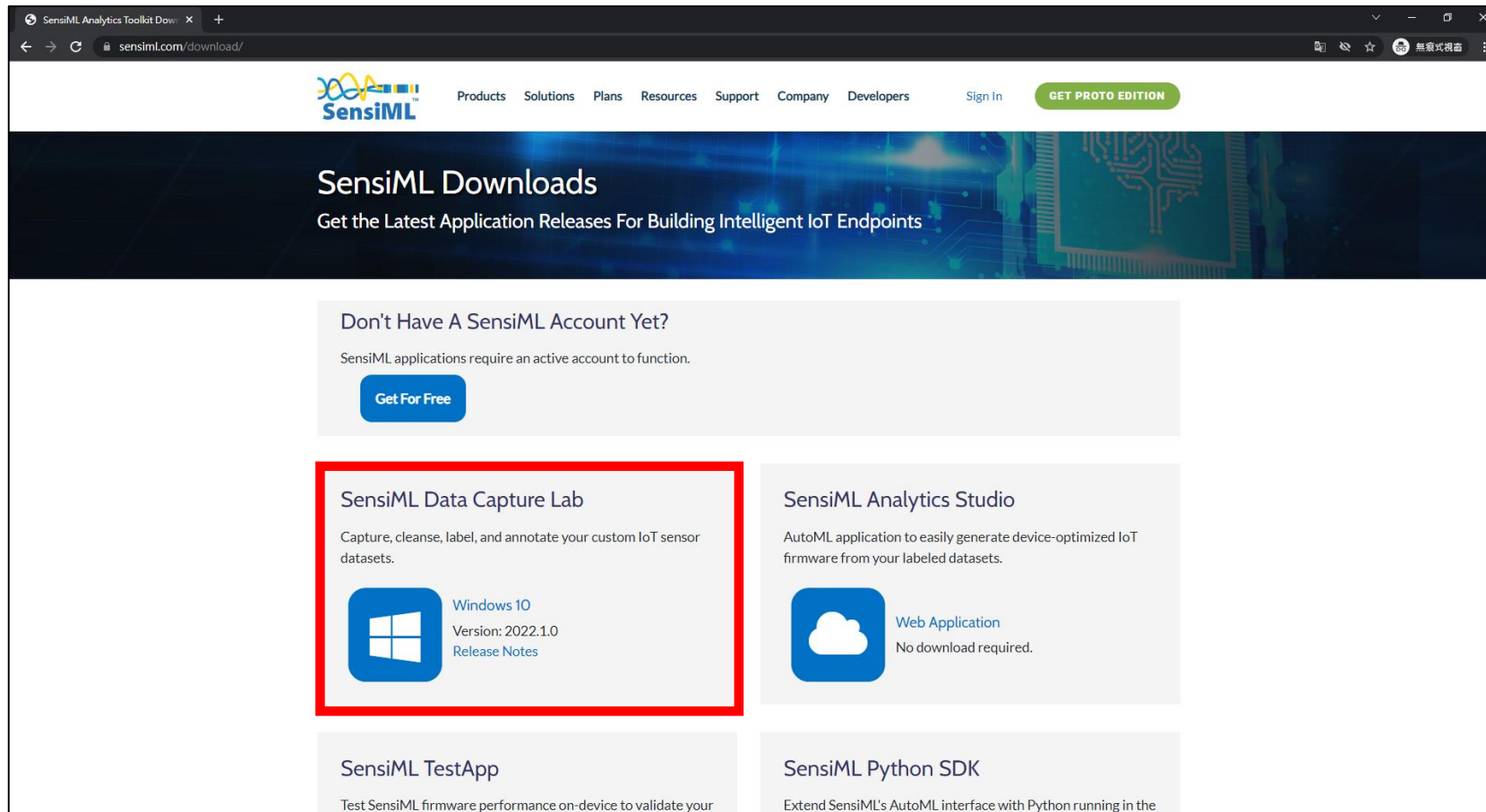

# 匯入 CoreMaker 設定檔

- 開啟 SensiML Data Capture Lab
- 登入帳號
- 建立專案

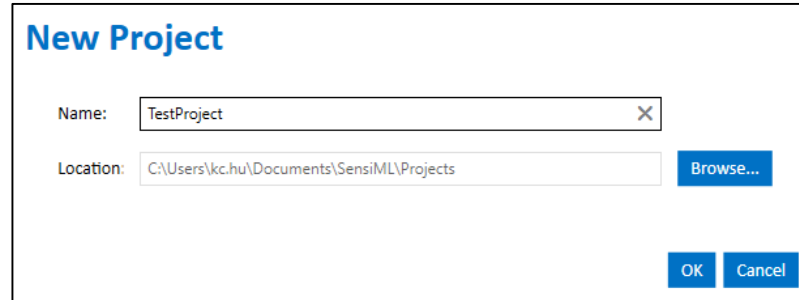

- 匯入 CoreMaker 設定檔，檔案位置在 CoreMaker-01/SensiML/AIOT2101-simple-stream.ssf

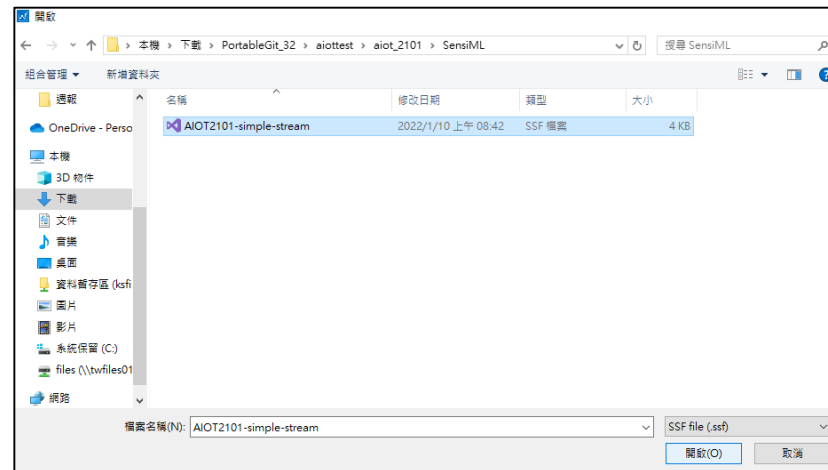
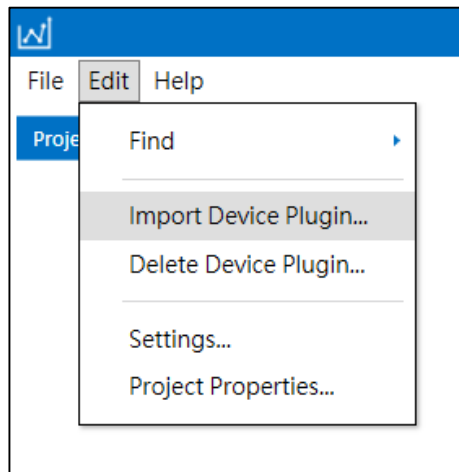



# 連接 CoreMaker (1)

- 點選“Switch modes”按鈕，選擇“Capture”
- 使用 Micro USB to USB 的線，連接 PC 與 CoreMaker

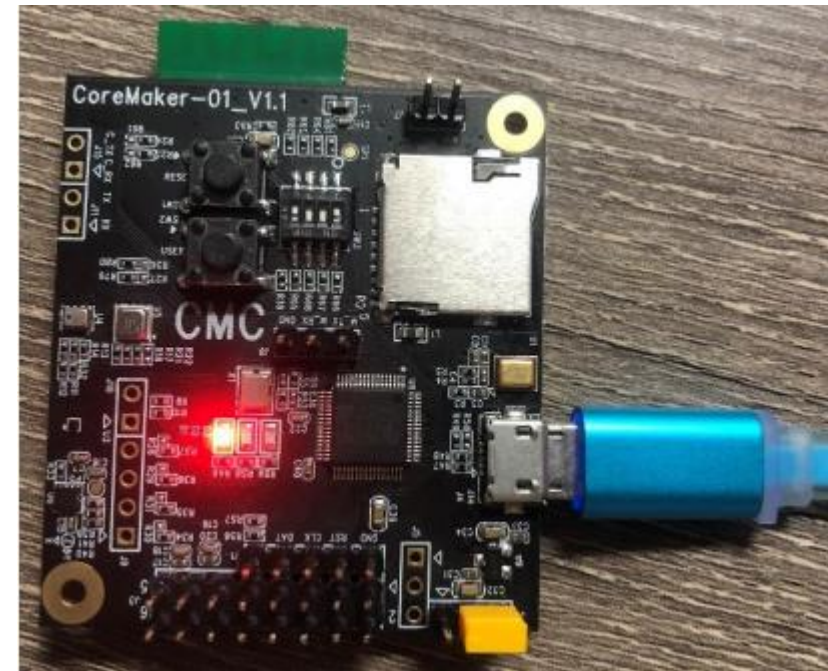
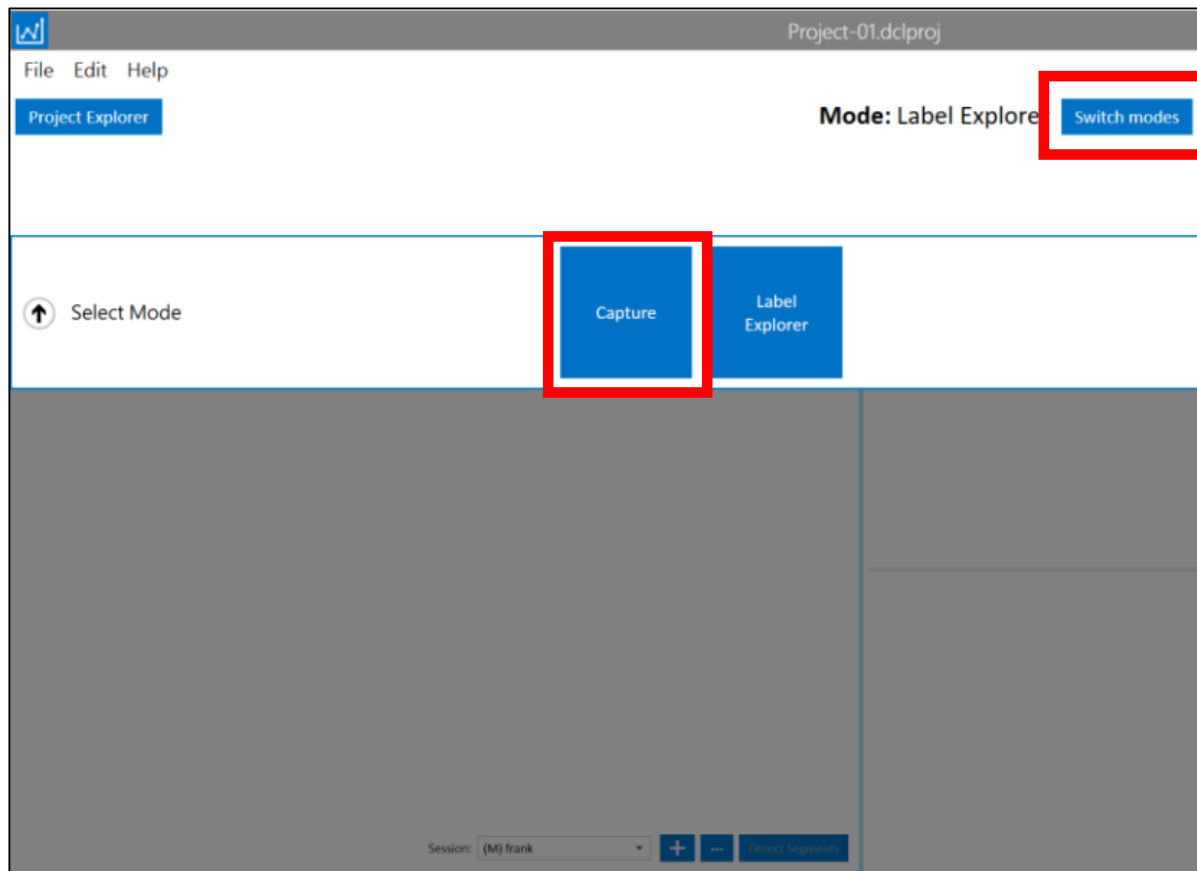

# 連接 CoreMaker (2)

- 進入 Capture 頁面後，點選頁面下方 CoreMaker-01 的“Connect”按鈕

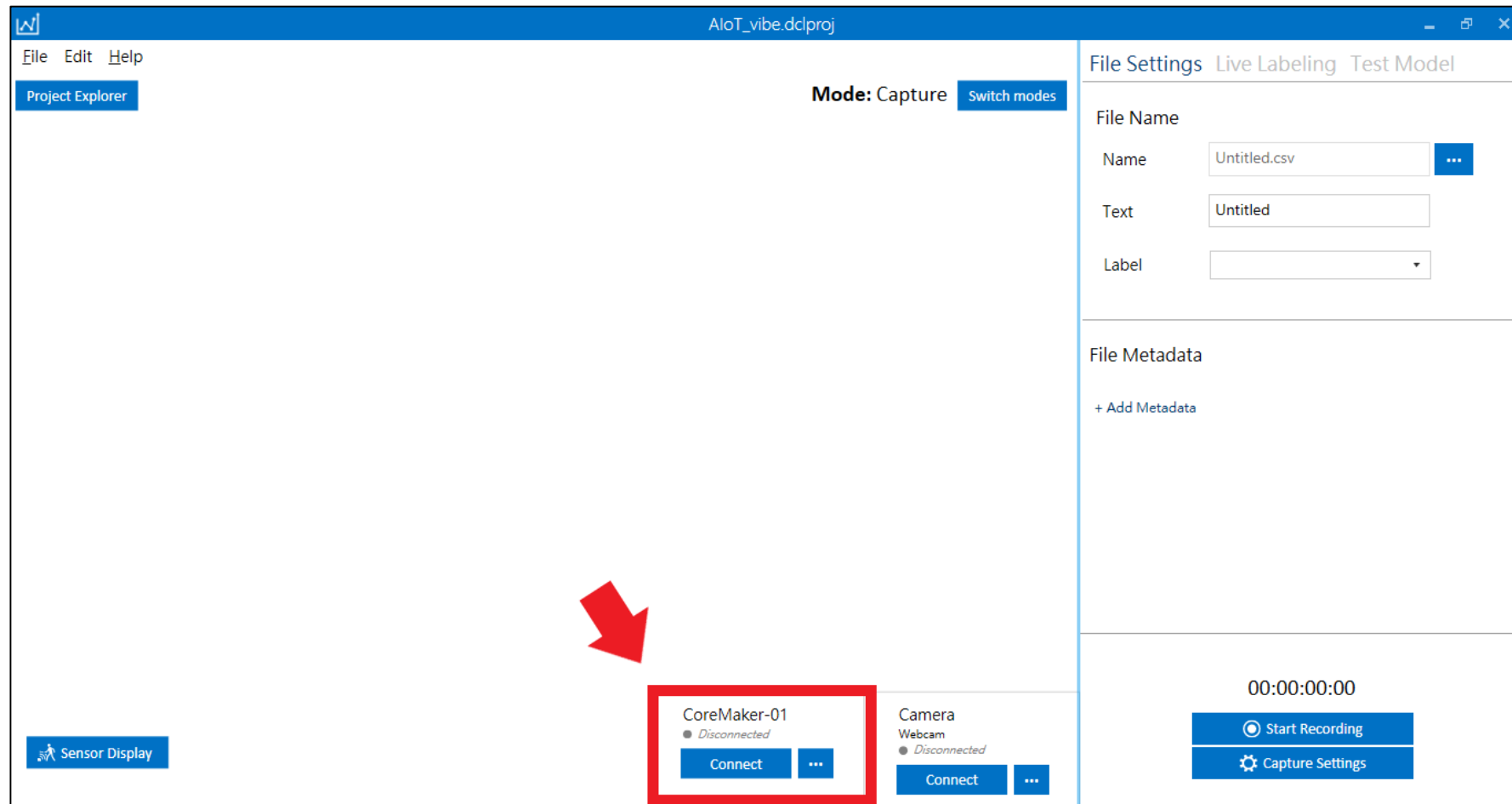

# 建立 Sensor Configuration (1)

- 第一次使用需要做 Device Plugin 的設定
- 跳出提示視窗後，點擊“Next”，進入選擇畫面
- 選擇名稱為“CoreMaker-01”的 device，點擊“Next”進入下一步

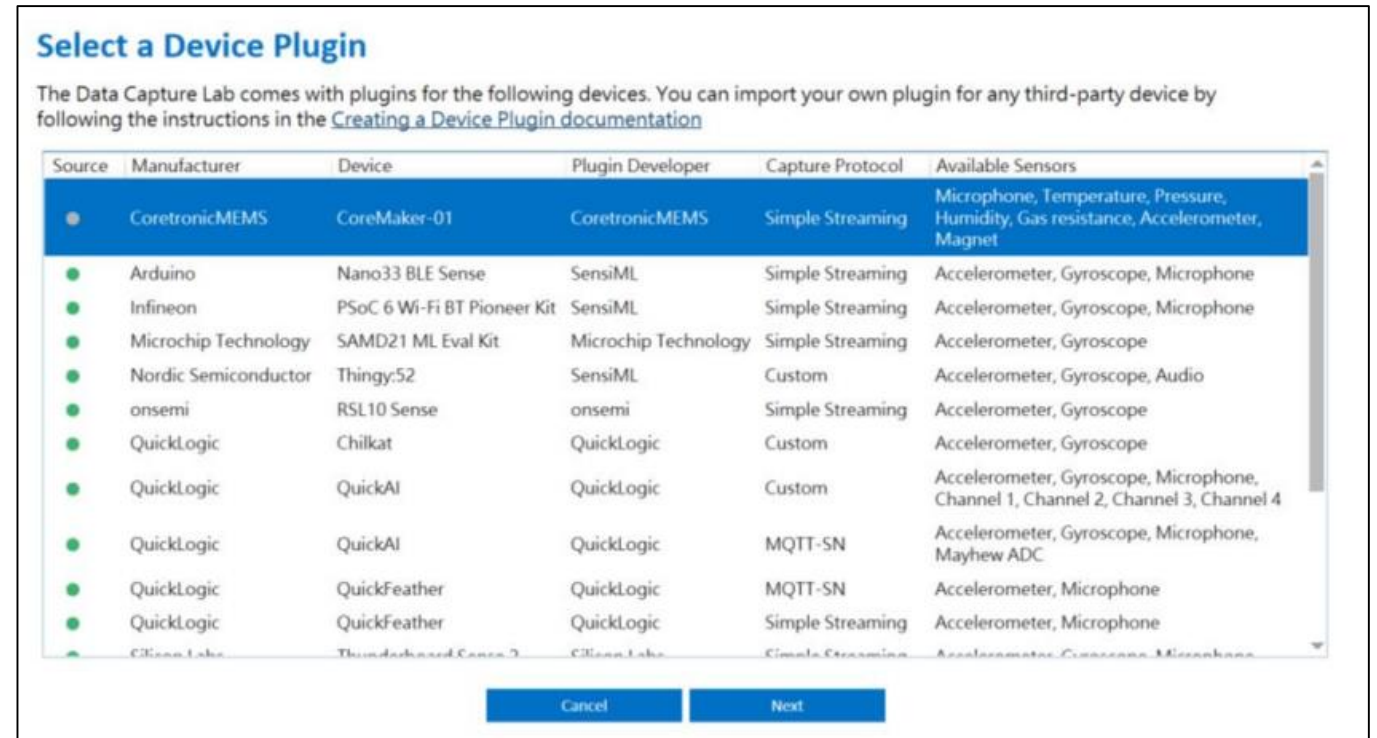
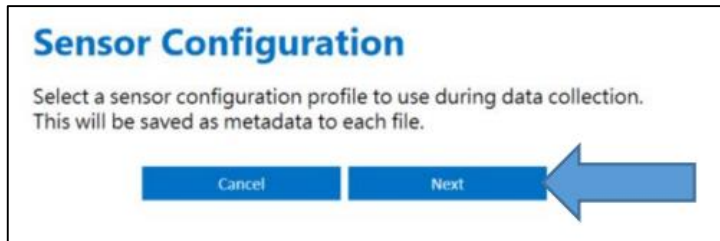

# 建立 Sensor Configuration (2)

- 出現顯示 Plugin Details 的畫面，點擊“Next”繼續
- 選擇 Capture Source、Sample Rate、及 Selected Sensors，設定完成點擊“Next”繼續
  - 以麥克風為範例，Capture Source 選擇“Audio”，Sample Rate 選擇“2000” (預設值)，Selected Sensors 勾選“Microphone”
  - Sample Rate 需選擇與 CoreMaker 韌體相同的設定值
- 接著輸入設定檔的名稱，可以自訂，輸入完點擊“Save”完成設定

### Plugin Details

Manufacturer: CoretronicMEMS  
Plugin Developer: CoretronicMEMS  
Capture Protocol: Simple Streaming  
Firmware Download: [Data Collection Firmware](#)

Sensor Summary:

Name: Audio  
Sensors: Microphone  
Sample Rates: 16000, 8000, 4000, 2000, 1000, 400, 200, 100

Name: Environment  
Sensors: Temperature, Pressure, Humidity, Gas resistance  
Sample Rates: 1

Name: Motion  
Sensors: Accelerometer  
Sample Rates: 12800, 6400, 3200, 1600, 800, 400, 200, 100, 50, 25

Name: Compass  
Sensors: Magnet  
Sample Rates: 200, 100, 50, 20, 10

[Back](#) [Next](#)

### Sensor Properties

Device Plugin  
CoreMaker-01

Capture Source

Sample Rate

Selected Sensors  
 Microphone

[Back](#) [Next](#)

### Save Sensor Configuration

Enter a profile name for your sensor configuration. This will be saved as metadata to any files that are collected using the selected configuration.

[Back](#) [Save](#)

# 建立 Sensor Configuration (3)

- Sample Rate 選擇預設值，各感測器預設值如下：
  - 聲音 (Audio) : 2000
  - 加速度 (Motion) : 3200
  - 環境 (Environment) : 1
  - 壓力 (Pressure) : 256

# 感測器資料輸出切換

- CoreMaker 有 4 種資料輸出模式，分別對應 4 個感測器
  1. 聲音
  2. 加速度
  3. 環境，包含壓力、溫度、濕度、空氣品質
  4. 壓力，包含壓力、溫度
- 切換方式為調動 SW3 的開關 2、3、4
  - 2: ON 3: OFF 4: ON -> 加速度
  - 2: OFF 3: ON 4: ON -> 環境
  - 2: ON 3: ON 4: ON -> 聲音
  - 2: ON 3: ON 4: OFF -> 壓力

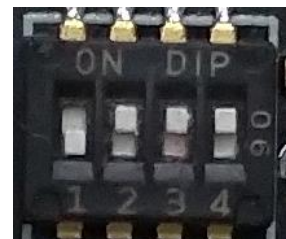

聲音

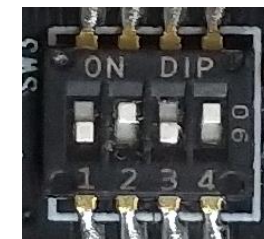

加速度

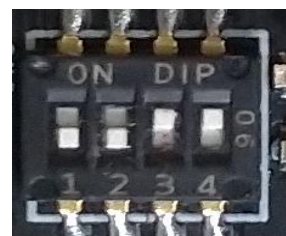

環境

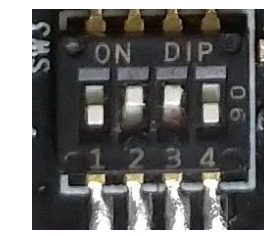

壓力

# 連線 CoreMaker 與 Data Capture Lab

- 進入 Connection Settings 頁面，點擊“Scan”後，會出現偵測到有連接裝置的连接埠，選擇连接埠後點擊“Done”完成設定
- 再次點擊“Connect”，當狀態列出現“Retrieving Configuration”時，**按壓 CoreMaker 上的 SW2 按鍵即可連線**
- 連線成功後，頁面中間會顯示輸入資料的波型圖
- 若連線失敗，或是波形圖異常(靜止狀態但波型變化劇烈，如下方右圖)，可按壓 SW1 (Reset) 按鍵，重新執行連線步驟

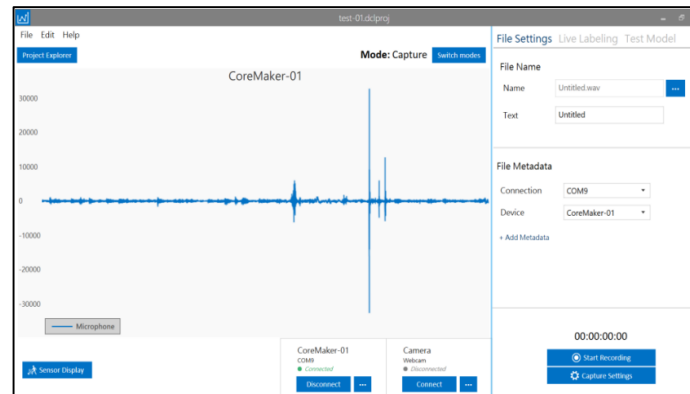

連線成功

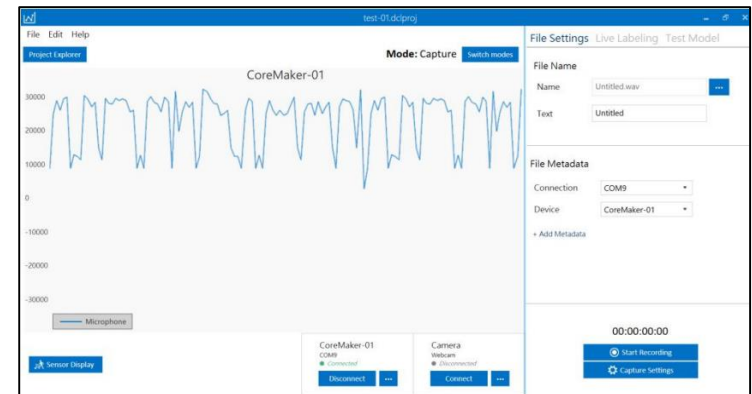

連線失敗



# 擷取資料

- 點擊視窗右下角的“Start Recording” 按鈕開始擷取資料
- 儲存檔案的位置預設在“文件\SensiML\Projects\[專案名稱]\data\”，檔案會以 .csv 格式儲存

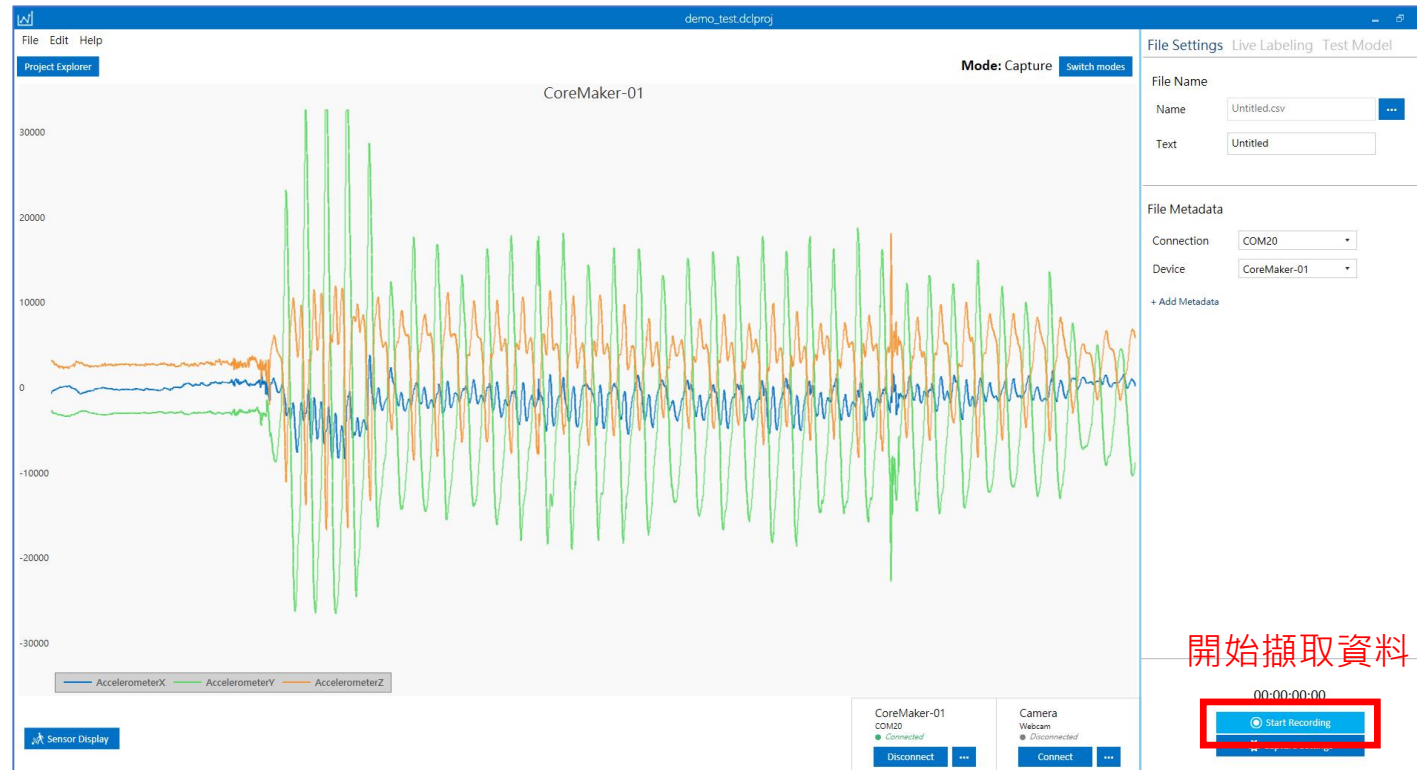

# 連線建立流程

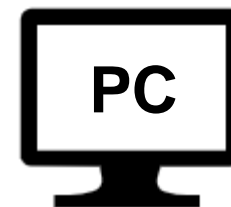
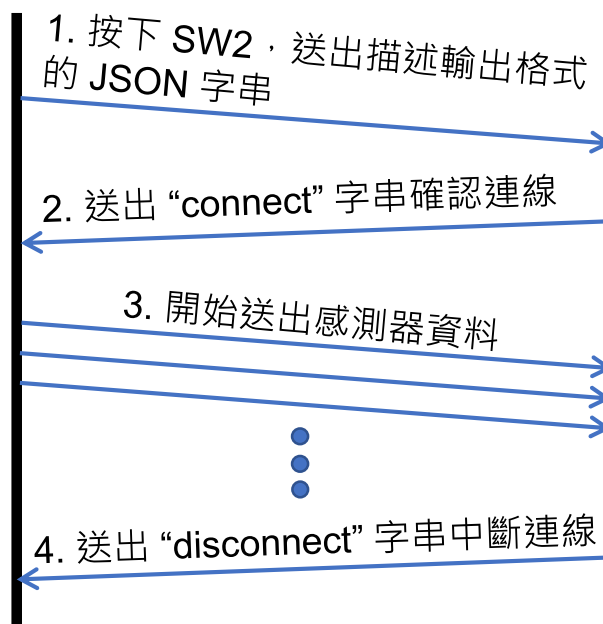

- 使用 UART 傳輸資訊
- 根據輸出格式的描述內容，依序送出感測器資料
- 感測器資料以 **8 位元無號整數** 傳送，因此接收端需要將資料合併成 **16 位元**，並且以 **有號整數** 的方式讀取，才會顯示正確的數值



# 建立 AI 模型

SensiML雲端平台使用教學

# 建立標籤

- 選擇 Edit 標籤下的“Project Properties” 選項
- 點擊“+” 增加標籤

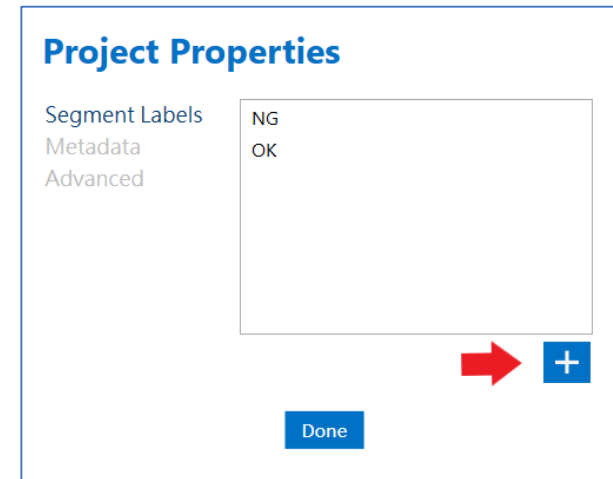
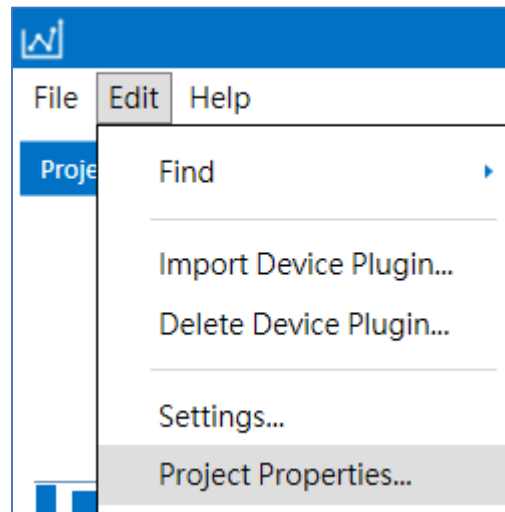

# 建立手動標記 Session

- 點選“Switch modes”按鈕，選擇“Label Explorer”
- 點擊視窗下方的“+”新增 session
- 在 Name 欄位輸入 session 名稱，Type 選擇“Manual”

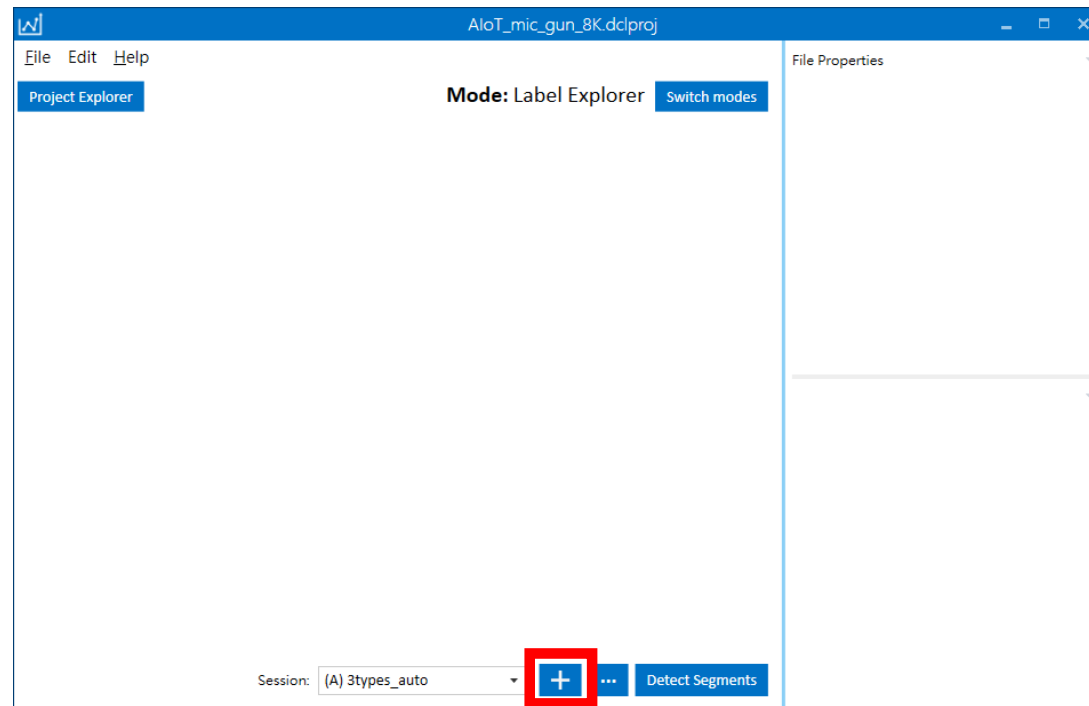

## New Labeling Session

A labeling session separates events into their own group. This allows you to work on multiple use cases using the same dataset

Name

Type  
 Manual  Auto

Manual:  
Create event labels by right-clicking on the graph. Segments can be edited by adjusting the location manually on the graph

# 標記資料

- 點選視窗左上方的“Project Explorer”按鈕，雙擊檔案名稱開啟檔案
- 在波形圖上點擊滑鼠右鍵，此時會出現紅色及藍色的垂直長線，以滑鼠拖動這兩條線來設定標記範圍
- 點選編輯按鈕編輯標記
- 標記完成後，點選“Save Changes”按鈕儲存

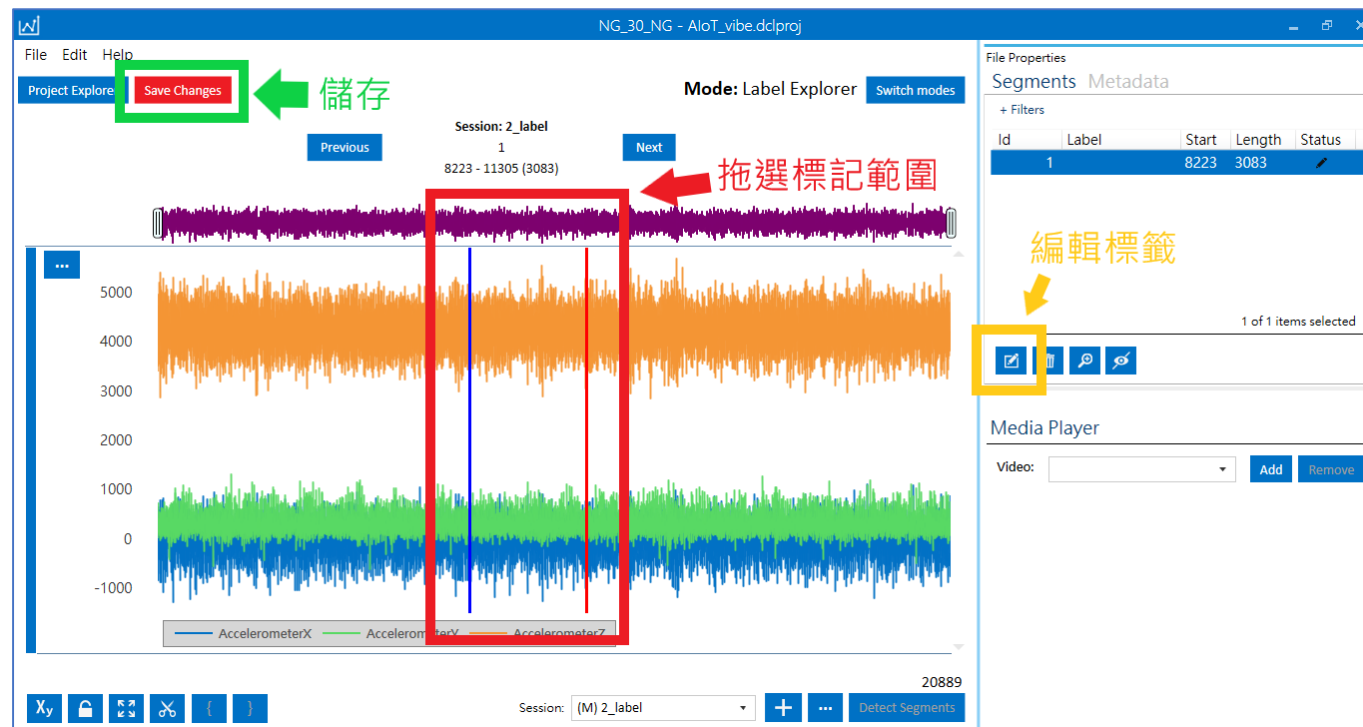



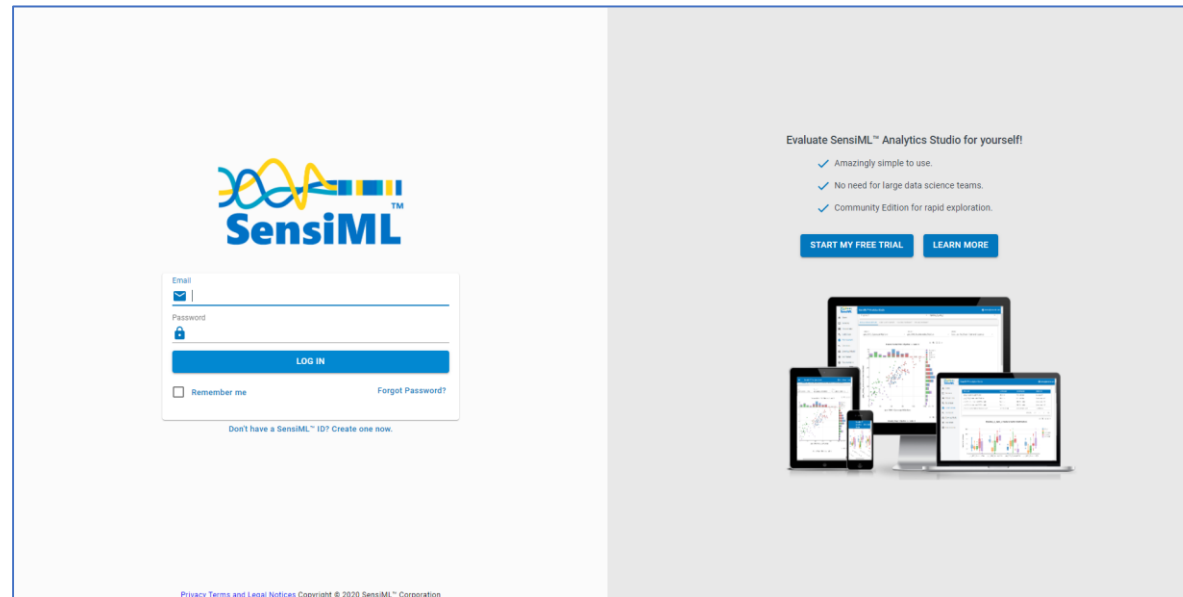

# 建立模型 (1)

- 進入 SensiML Analytics Studio 網頁 (<https://app.sensiml.cloud/auth/login/>)
- 登入帳號



- 打開 project

Open Project									
	NAME	FILES	PIPELINES	SIZE (MB)	QUERIES	MODELS	SEGMENTS	CREATED DATE	DELETE
	AIOT2101	0	0	0	0	0	0	2022/1/4	

# 建立模型 (2)

- 在 Prepare Data 頁面中建立新的 Query
  - 輸入 Query 名稱
  - 選擇使用的 Session
  - 選擇使用的 Label
  - 選擇 Plot 依據
  - 選擇完成點擊 “Save” 儲存

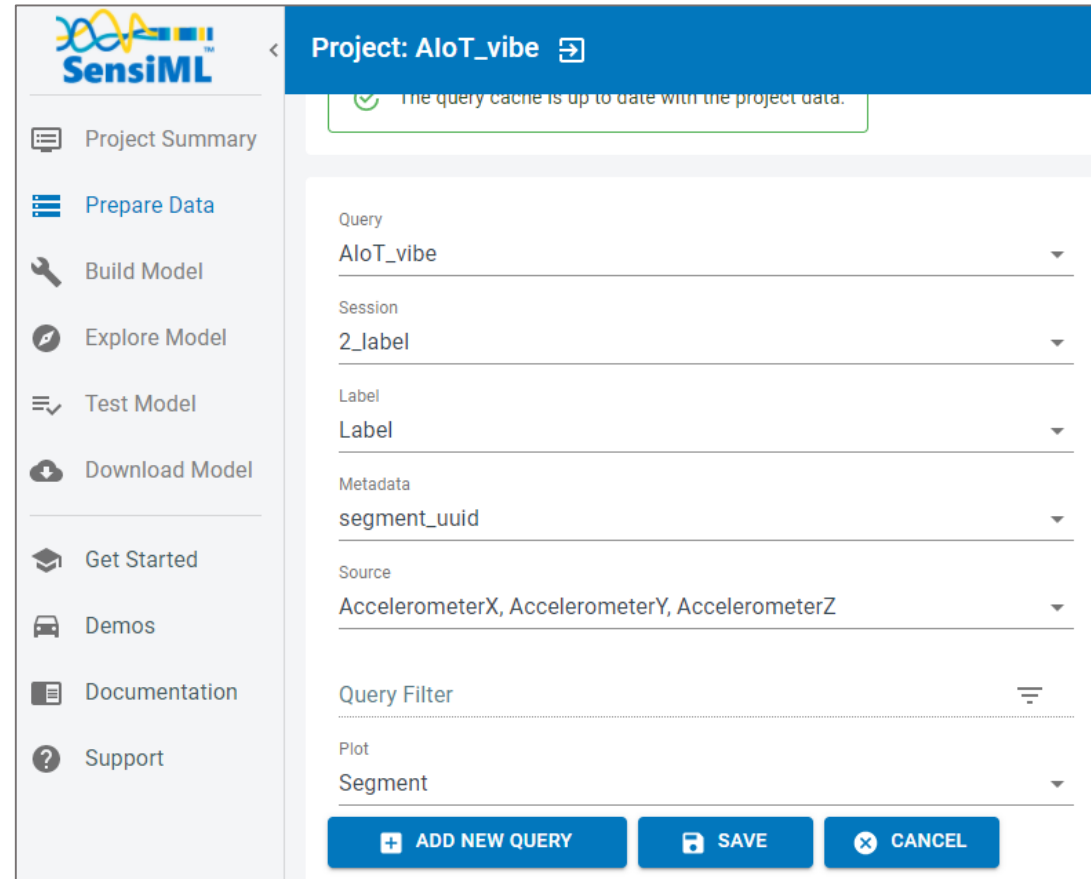

# 建立模型 (3)

- 在 Build Model 頁面中建立模型
  - 點擊“BUILD MODEL”按鈕建立新的 pipeline
  - 點擊“OPTIMIZE”按鈕自動建立模型
- 關於建立模型的詳細設定，請參考 <https://sensiml.com/documentation/guides/getting-started/index.html>

### Create New Pipeline

Pipelines are individual workspaces where you can build machine learning models against your labeled data sets.

- You will be able to select the components of the pipeline including digital signal processing, feature extraction, sampling techniques and the Machine Learning algorithms.
- Pipelines create a cache at each step so you can quickly iterate your models.

**BUILD MODEL**

Name: AIoT\_vibe  
Type: Input Query

Name: Windowing  
Type: Segmenter





Type: AutoML Parameters

Classifier SRAM	32000
f1-score	100

**▶ OPTIMIZE**

# 建立模型 (4)

- Pipeline 運行完成後，會建立 5 個模型
- 差別在於使用的分類器空間大小及特徵數量，使用者可根據需求選擇下載合適的模型
- 不同的分類器大小及特徵數量會影響模型的準確度

AutoML Results						
MODEL NAME	ACCURACY	CLASSIFIER SIZE(B)	NUM. FEATURES	SENSITIVITY	F1-SCORE	
fixed_window_size_rank_0	63	3049	24	61	63	
fixed_window_size_rank_1	66	2149	12	62	62	
fixed_window_size_rank_2	69	1849	8	60	61	
fixed_window_size_rank_3	65	3274	27	58	60	
fixed_window_size_rank_4	64	1340	4	55	58	

# 下載模型、編譯、燒錄

- 在 Download Model 頁面中，選擇以下設定
  - HW Platform: [ARM GCC Generic](#)
  - Processor: [ARM Cortex M4](#)
  - Float Options: [Soft FP](#)
  - Compiler: [GNU ARM Embedded \(none-eabi\) 10.3.1](#) (選擇符合的版本)
  - Format: [Library](#)
  - 其他設定不用修改
- 點選“DOWNLOAD”下載模型
- 解壓縮下載的檔案，用裡面的 libsensiml 資料夾覆蓋 CoreMaker-01 下的 libsensiml 資料夾
- 進行編譯韌體及燒錄

### Download Knowledge Pack

**Target Device Options:**

HW Platform  
ARM GCC Generic

Processor  
ARM Cortex M4

Float Options  
Soft FP

Compiler  
GNU Arm Embedded (none-eabi) 10.3.1

Format  
Library

Data Source  
AloT\_vibe

Application  
SensiML AI Model Runner

Output  
Serial

[Advanced Settings](#)

[DOWNLOAD](#)

# 模型Library替換

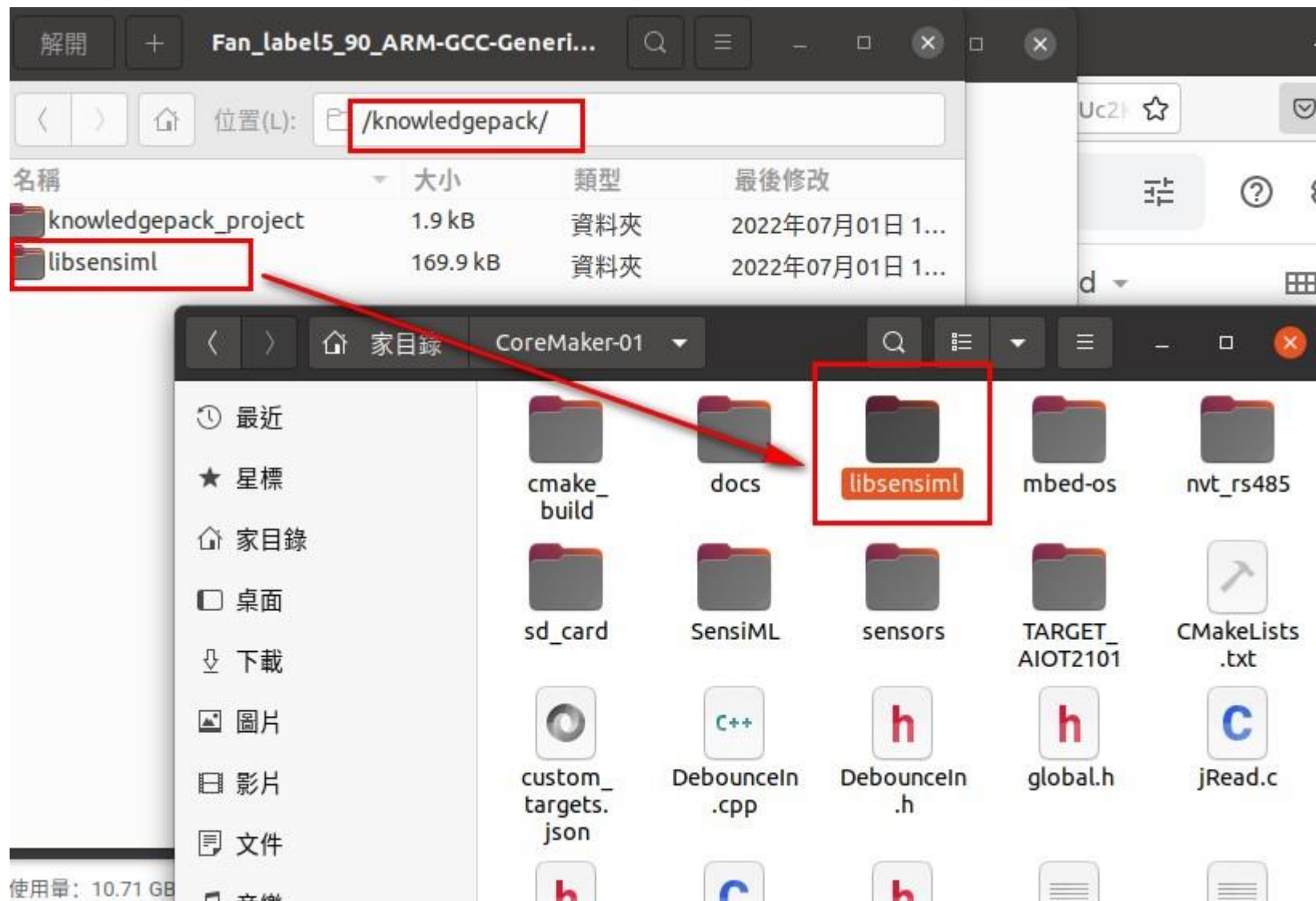

1. 下載SensiML的knowledgepack
2. 將libsensiml取代原資料夾中的檔案
3. 重新Build code產生bin檔
4. 燒錄bin檔到開發板



# Build bin檔

請參閱後方開發環境設定

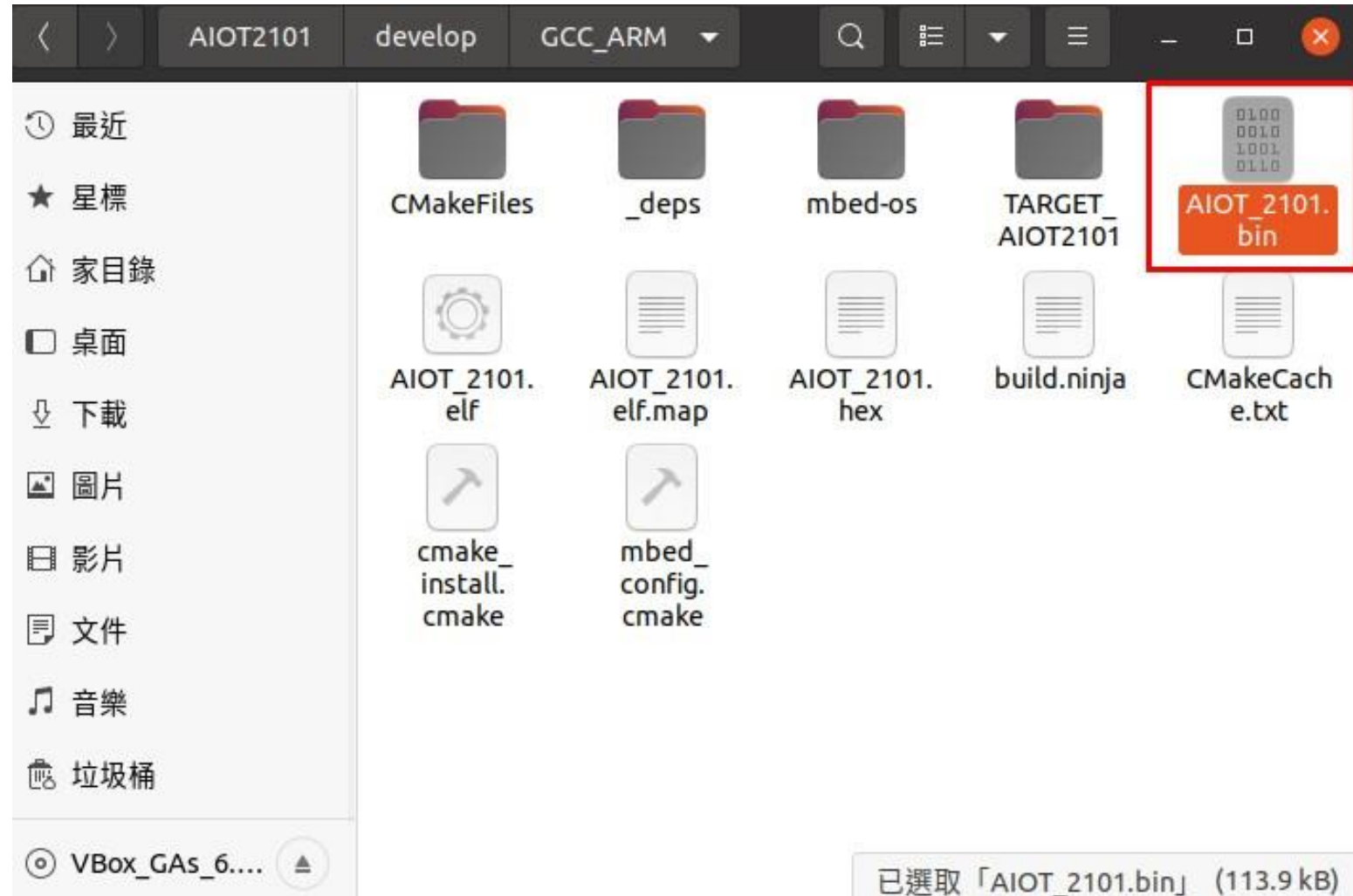





# CoreMaker 開發環境架設

# 開發環境及必須安裝套件

- 作業系統
  - Windows 10
- 必須安裝套件
  - Git — 下載韌體原始檔使用
  - Python
  - CMake
  - Ninja
  - Mbed CLI 2
  - GNU Arm Embedded Toolchain } 編譯韌體使用
- 詳細步驟請參考 <https://github.com/CoretronicMEMS/CoreMaker-01/> 中 docs 資料匣內的 coremaker操作指南\_V1.1.pdf

# Python 安裝注意事項

- 3.6 以上版本
- 安裝時勾選 Add Python 3.10 to PATH

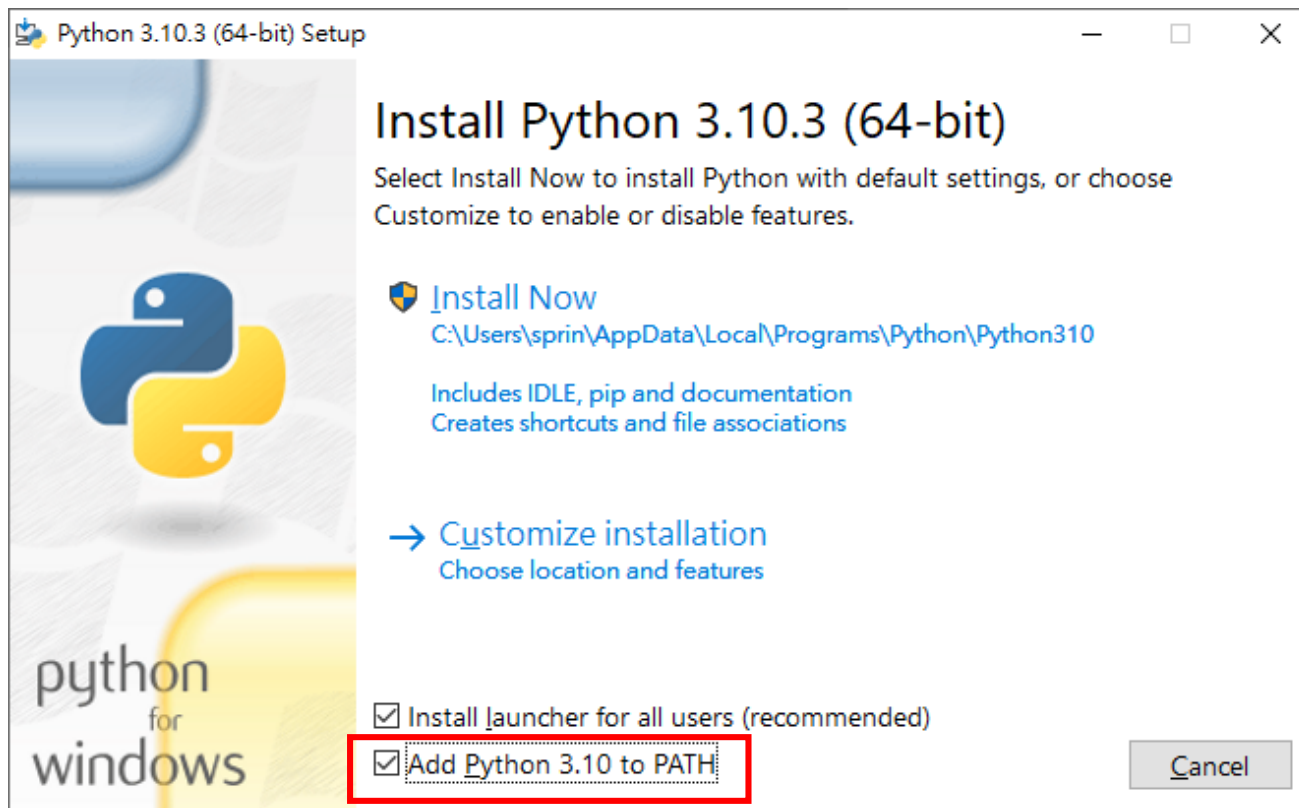

# CMake 安裝注意事項

- 3.19.0 以上版本
- 安裝時選則 Add CMake to the system PATH for all users 或 Add CMake to the system PATH for the current user

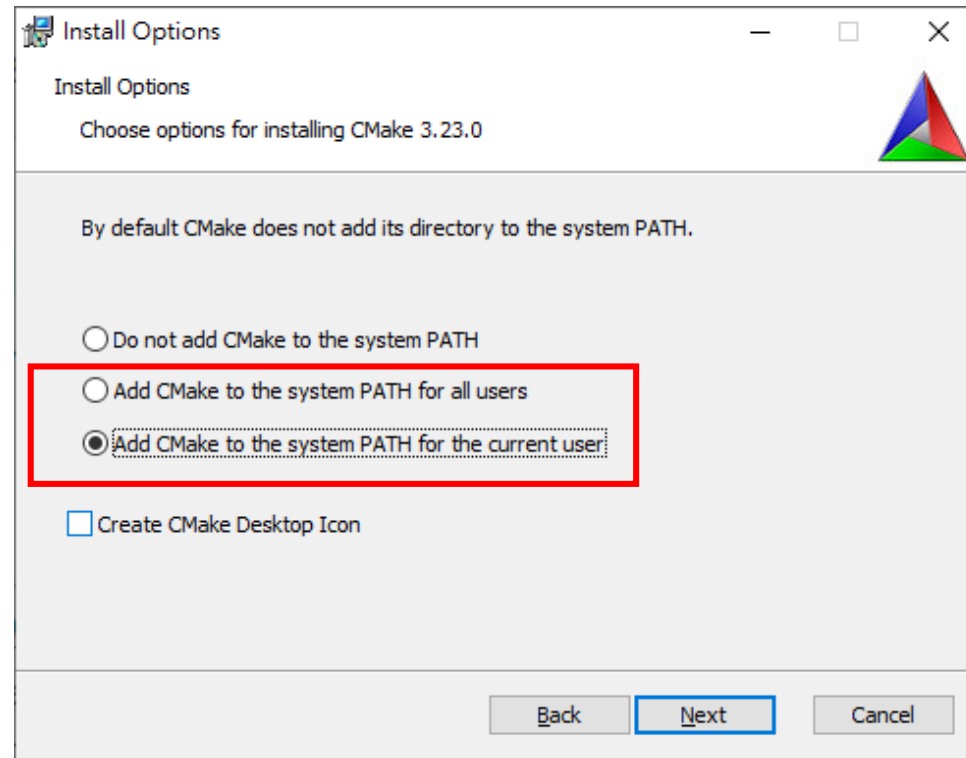



# GNU Arm Embedded Toolchain 安裝注意事項

- 若 PC 上已有安裝舊版或是其他版本的 cross compiler，請先移除，確保安裝後能正常執行
- 安裝完勾選 Add path to environment variable

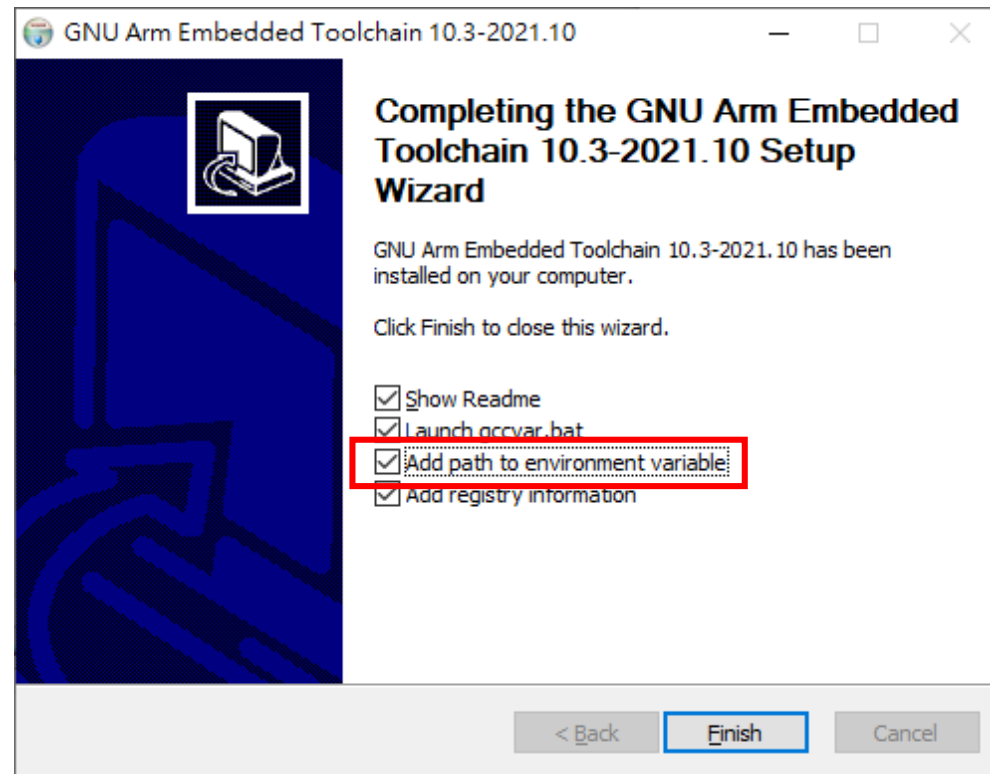

# 其他注意事項

- 以上套件安裝完成後，需重新開機



# 開發流程

- 以 LED 燈效控制為例

# 下載韌體原始程式

- 在“命令提示字元”下，輸入“`git clone --recurse-submodules https://github.com/CoretronicMEMS/CoreMaker-01.git`”
- 或是使用 GitHub Desktop 等軟體下載完整程式

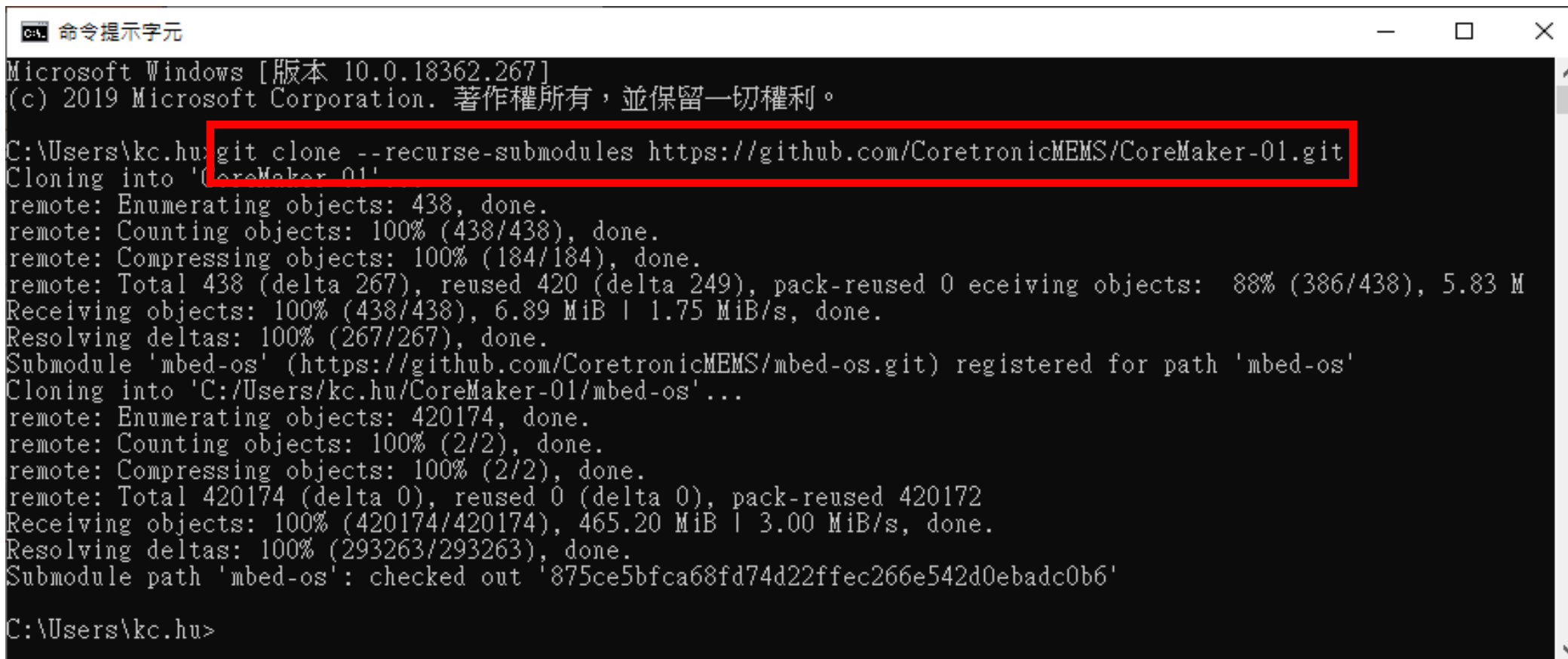

```
命令提示字元
Microsoft Windows [版本 10.0.18362.267]
(c) 2019 Microsoft Corporation. 著作權所有，並保留一切權利。

C:\Users\kc.hu> git clone --recurse-submodules https://github.com/CoretronicMEMS/CoreMaker-01.git
Cloning into 'CoreMaker-01'...
remote: Enumerating objects: 438, done.
remote: Counting objects: 100% (438/438), done.
remote: Compressing objects: 100% (184/184), done.
remote: Total 438 (delta 267), reused 420 (delta 249), pack-reused 0
Receiving objects: 100% (438/438), 6.89 MiB | 1.75 MiB/s, done.
Resolving deltas: 100% (267/267), done.
Submodule 'mbed-os' (https://github.com/CoretronicMEMS/mbed-os.git) registered for path 'mbed-os'
Cloning into 'C:/Users/kc.hu/CoreMaker-01/mbed-os'...
remote: Enumerating objects: 420174, done.
remote: Counting objects: 100% (2/2), done.
remote: Compressing objects: 100% (2/2), done.
remote: Total 420174 (delta 0), reused 0 (delta 0), pack-reused 420172
Receiving objects: 100% (420174/420174), 465.20 MiB | 3.00 MiB/s, done.
Resolving deltas: 100% (293263/293263), done.
Submodule path 'mbed-os': checked out '875ce5bfca68fd74d22ffec266e542d0ebadc0b6'

C:\Users\kc.hu>
```

# 增加 LED 燈效控制程式

- 使用編輯器開啟 `CoreMaker-01/main.cpp`
- 在第 102 行增加 “`led_g.Flash(100);`” 這段程式碼

```
87 while (1)
88 {
89     uint flags = mainEvent.wait_any(0xFFFF, 1000);
90     if (!(flags & osFlagsError))
91     {
92         if (flags & SW3_EVENT)
93             SwitchChanged();
94         if (flags & SW2_EVENT)
95             sensorHub.ButtonPress();
96         if (flags & UART_EVENT)
97             onSerialReceived();
98     }
99     else if (flags == osFlagsErrorTimeout) // No event
100     {
101     }
102 }
103
104 return 0;
105 }
```



```
87 while (1)
88 {
89     uint flags = mainEvent.wait_any(0xFFFF, 1000);
90     if (!(flags & osFlagsError))
91     {
92         if (flags & SW3_EVENT)
93             SwitchChanged();
94         if (flags & SW2_EVENT)
95             sensorHub.ButtonPress();
96         if (flags & UART_EVENT)
97             onSerialReceived();
98     }
99     else if (flags == osFlagsErrorTimeout) // No event
100     {
101     }
102     led_g.Flash(100);
103 }
104
105 return 0;
106 }
```

# 編譯韌體

- 輸入“cd CoreMaker-01”進入韌體程式所在的資料夾
- 輸入“mbed-tools compile -m AIOT2101 -t GCC\_ARM”開始編譯，初次編譯需要較長的時間
- 編譯完成會在 CoreMaker-01\cmake\_build\AIOT2101\develop\GCC\_ARM\ 內，產生 AIOT\_2101.bin

```
命令提示字元
Microsoft Windows [版本 10.0.18362.267]
(c) 2019 Microsoft Corporation. 著作權所有，並保留一切權利。
C:\Users\kc.hu>cd CoreMaker-01
C:\Users\kc.hu\CoreMaker-01>mbed-tools compile -m AIOT2101 -t GCC_ARM
```

編譯指令

```
命令提示字元
-- built: C:/Users/kc.hu/CoreMaker-01/cmake_build/AIOT2101/develop/GCC_ARM/AIOT_2101.bin
-- built: C:/Users/kc.hu/CoreMaker-01/cmake_build/AIOT2101/develop/GCC_ARM/AIOT_2101.hex
C:\Users\kc.hu\CoreMaker-01>_
```

燒錄檔案生成處

# 進入燒錄模式

1. 使用 Micro USB to USB 轉接線，連接 CoreMaker 與 PC
2. 同時按下 SW1 及 SW2
3. 先放開 SW1，再放開 SW2
4. CoreMaker 上的紅色 LED 不再閃爍，表示進入燒錄模式，若紅色 LED 仍然閃爍，重複步驟 2 跟 3

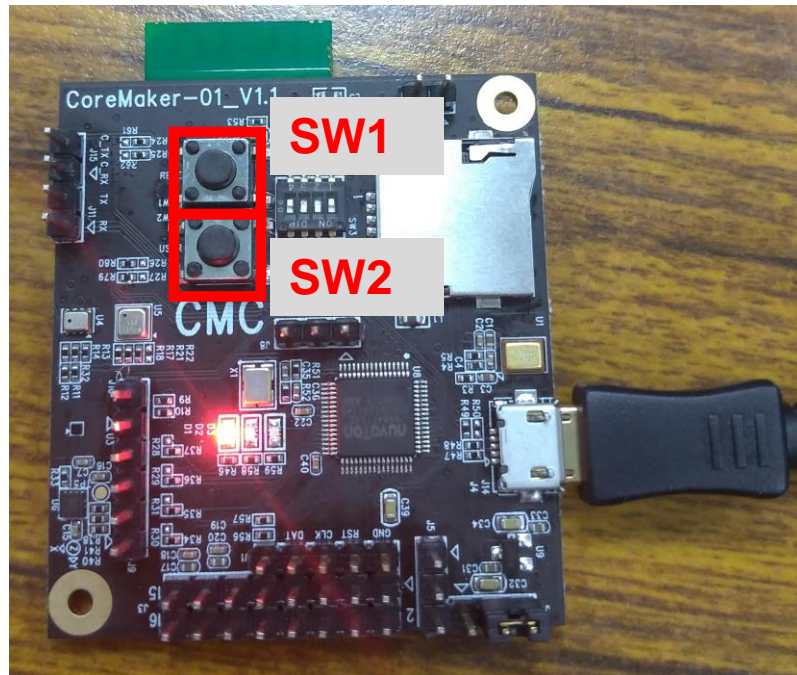

一般模式

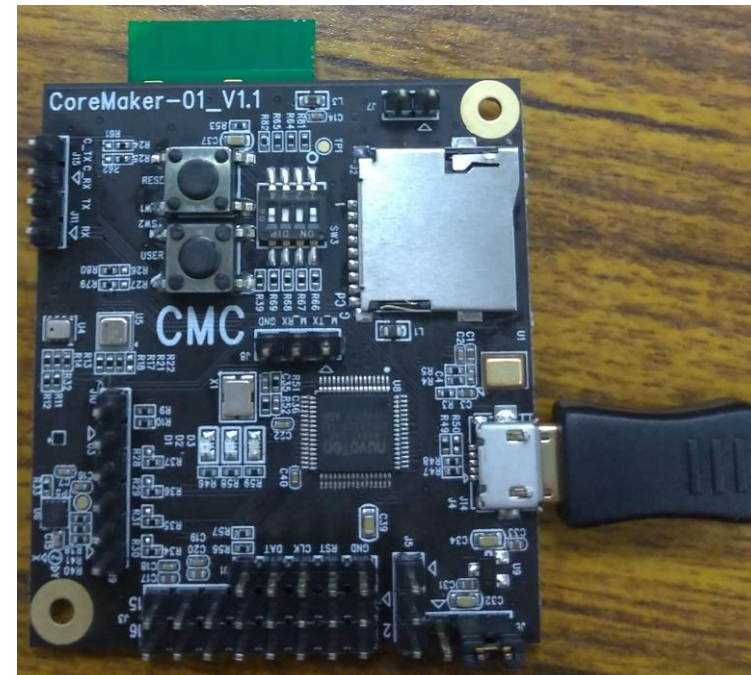

燒錄模式



# 燒錄程式 (1)

- 解壓縮 CoreMaker-01/CMC\_ISP/CMC\_ISP.zip
- 執行解開後的 CMC\_ISP.exe 開啟程式

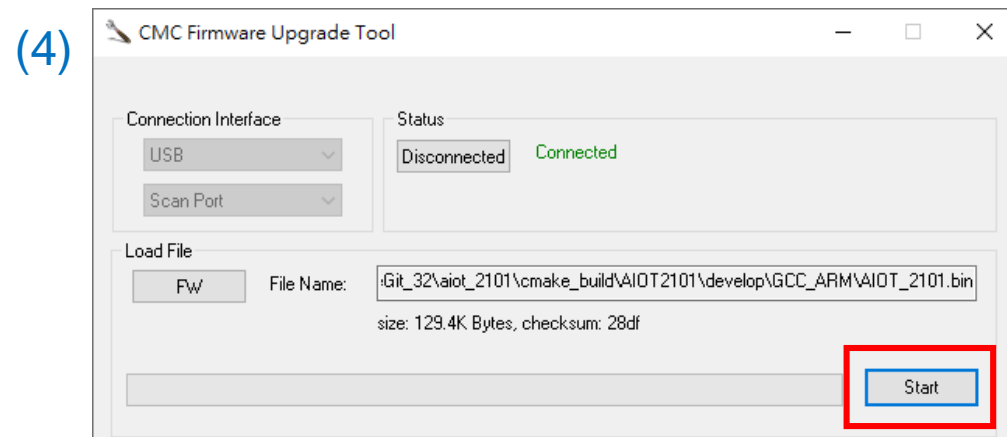
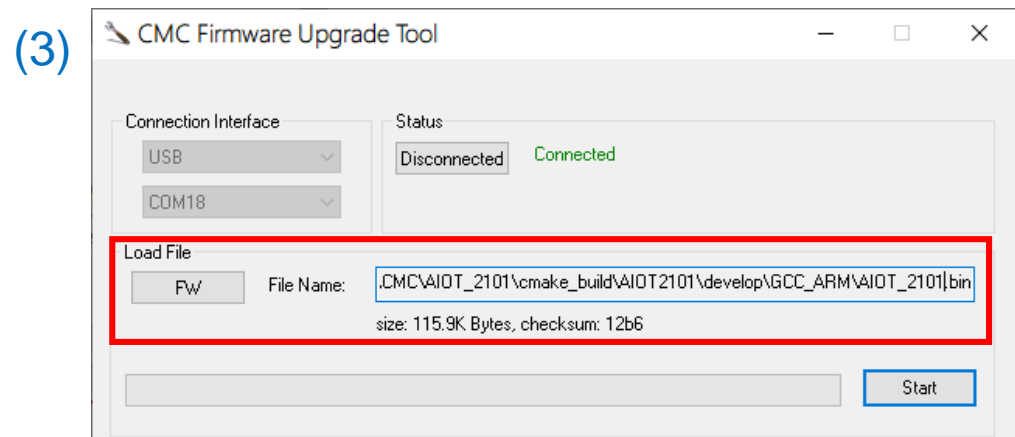
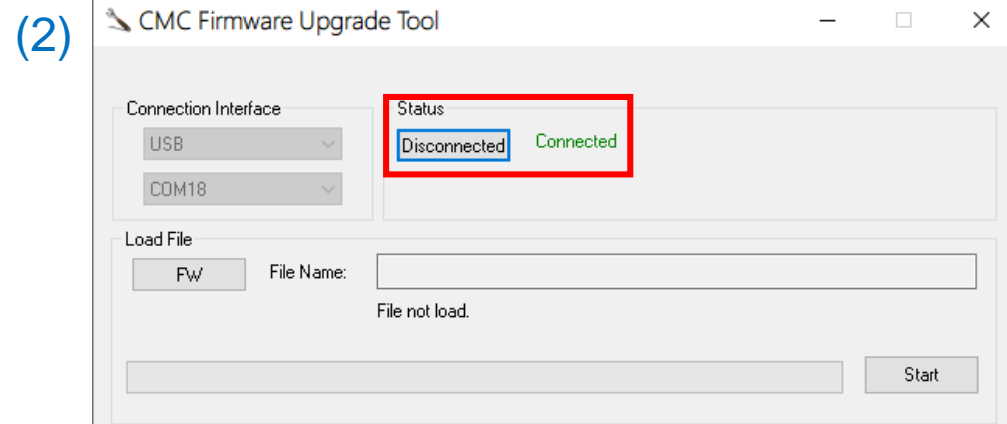
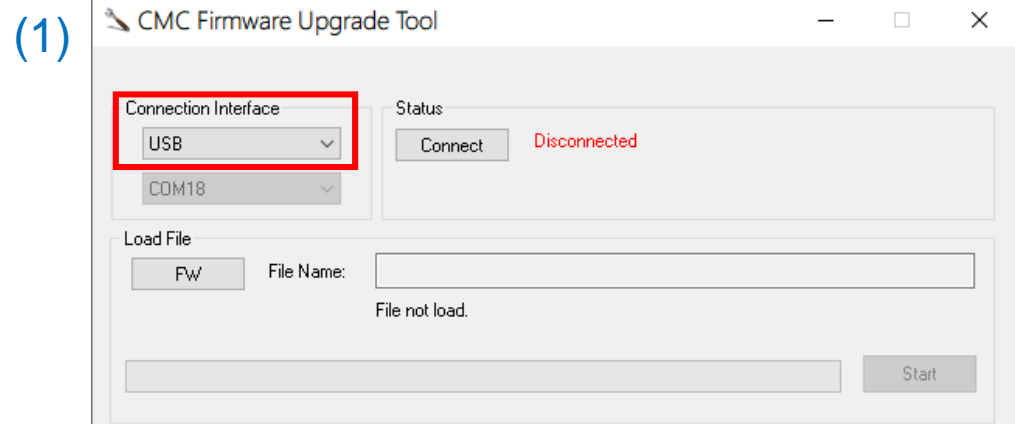

# 燒錄程式 (2)

- 燒錄成功會出現成功訊息

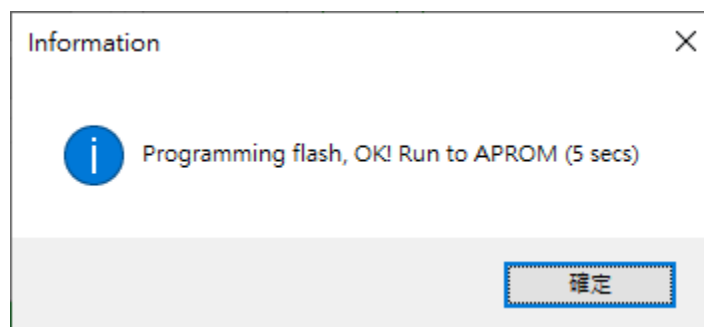
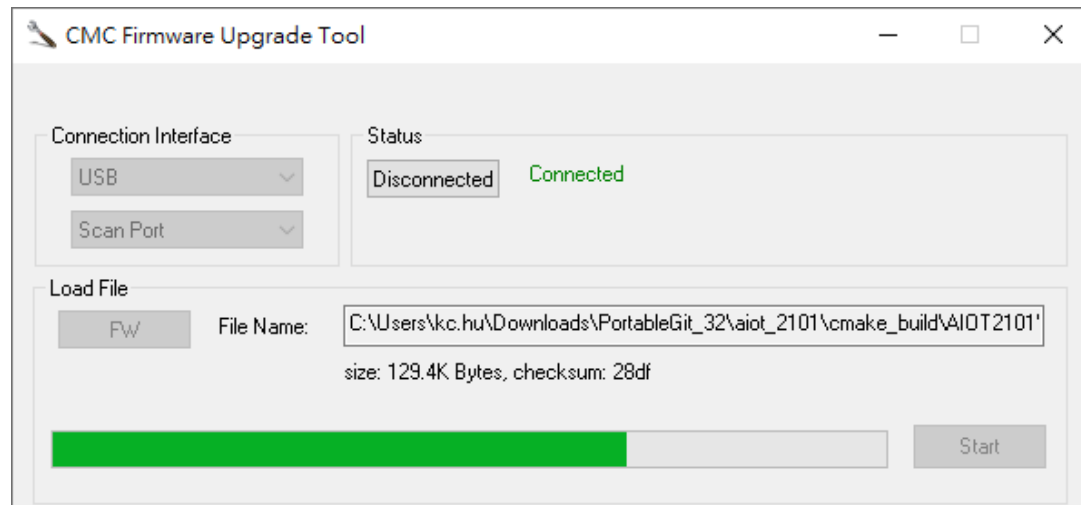

# 燒錄完成

- 燒錄成功後，CoreMaker 會自動回復為一般模式，此時可以發現 LED 綠燈每 0.1 秒會閃爍一次

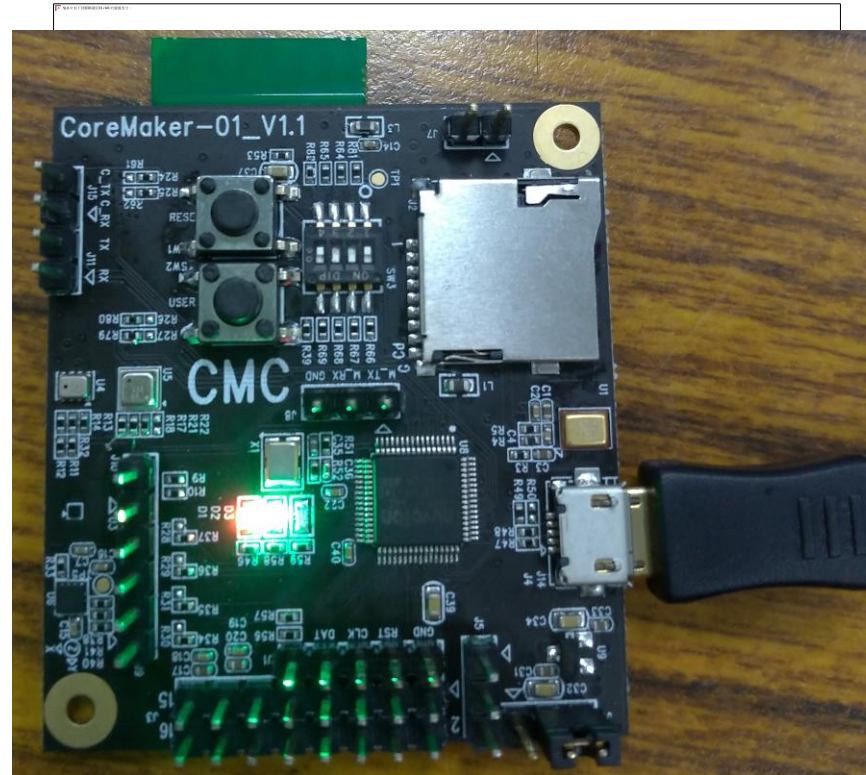

# 修改 Sample Rate

# 修改 Sample Rate

- 使用編輯器開啟 [CoreMaker-01/sensors/SensorHub.cpp](#)
- 第 56 行到第 60 行為各 sensor 的宣告，紅框內數字的部分就是各 sensor 的 sample rate
  - acoustic\_node：聲音，可設定值為 [100, 200, 400, 1000, 2000, 4000, 8000, 16000]
  - bme680：環境，可設定值為 [1]
  - gmp102：壓力，可設定值為 [256, 512, 1024, 2048, 4096, 8192, 16384, 32768]
  - gmc306：磁力，可設定值為 [10, 20, 50, 100, 200]
  - kx122：加速度，可設定值為 [25, 50, 100, 200, 400, 800, 1600, 3200, 6400, 12800]

```
56     AcousticNode acoustic_node(PB_6, 2000);  
57     BME680 bme680(0x76 << 1, &i2c1);  
58     GMP102 gmp102(&i2c1, 256);  
59     GMC306 gmc306(&i2c1, 10);  
60     KX122 kx122(&spi0, PA_10, 3200);
```

# 建立新 Sensor Configuration (1)

- 開啟 Data Capture Lab，進入 Capture mode
- 點擊 CoreMaker-01 方塊內的“...”，選擇“Change Sensor Configurator”
- 點擊“Add new configuration”

The screenshot shows the Data Capture Lab interface with the Sensor Configuration dialog box open. The dialog box contains the following table:

Profile Name	Sensors	Sample Rate	Manufacturer	Device	Plugin Developer	Cap
AloT_compass	Magnet	10	CoretronicMEMS	CoreMaker-01	CoretronicMEMS	Sim
AloT_env	Temperature, Pressure, Humidity, Gas resistance	1	CoretronicMEMS	CoreMaker-01	CoretronicMEMS	Sim
AloT_mic_ML	Microphone	2000	CoretronicMEMS	CoreMaker-01	CoretronicMEMS	Sim
AloT_mov	Accelerometer	6400	CoretronicMEMS	CoreMaker-01	CoretronicMEMS	Sim

Buttons at the bottom of the dialog box: Add new configuration, Cancel, Select.

# 建立新 Sensor Configuration (2)

- 選擇名稱為“CoreMaker-01”的 device
- 在 Sensor Properties 視窗內，選擇修改後的 Sample Rate
- 最後輸入設定名稱，儲存設定

### Select a Device Plugin

The Data Capture Lab comes with plugins for the following devices. You can import your own plugin for any third-party device by following the instructions in the [Creating a Device Plugin documentation](#)

Source	Manufacturer	Device	Plugin Developer	Capture Protocol	Available Sensors
<input checked="" type="radio"/>	CoretronicMEMS	CoreMaker-01	CoretronicMEMS	Simple Streaming	Microphone, Temperature, Pressure, Humidity, Gas resistance, Accelerometer, Magnet
<input type="radio"/>	CoretronicMEMS	CoreMaker-01	CoretronicMEMS	Simple Streaming	Microphone, Temperature, Pressure, Humidity, Gas resistance, Accelerometer, Magnet
<input type="radio"/>	Nuvoton	M487_MIC	Nuvoton	Simple Streaming	Microphone
<input checked="" type="radio"/>	Arduino	Nano33 BLE Sense	SensiML	Simple Streaming	Accelerometer, Gyroscope, Microphone
<input checked="" type="radio"/>	Arduino	Nicla Sense ME	SensiML	Simple Streaming	Accelerometer, Gyroscope
<input checked="" type="radio"/>	Infineon	PSoC 6 Wi-Fi BT Pioneer Kit	SensiML	Simple Streaming	Accelerometer, Gyroscope, Microphone
<input checked="" type="radio"/>	Microchip Technology	SAMD21 ML Eval Kit	Microchip Technology	Simple Streaming	Accelerometer, Gyroscope
<input checked="" type="radio"/>	Nordic Semiconductor	Thingy:52	SensiML	Custom	Accelerometer, Gyroscope, Audio
<input checked="" type="radio"/>	onsemi	RSL10 Sense	onsemi	Simple Streaming	Accelerometer, Gyroscope
<input type="radio"/>	Quicklogic	Chillat	Quicklogic	Custom	Accelerometer, Gyroscope

### Sensor Properties

**Device Plugin**  
CoreMaker-01

**Capture Source**

**Sample Rate**

**Selected Sensors**  
 Microphone

### Save Sensor Configuration

Enter a profile name for your sensor configuration. This will be saved as metadata to any files that are collected using the selected configuration.





# AI 資料輸入及結果輸出

- 使用編輯器開啟 `CoreMaker-01/sensors/SensorHub.cpp`
- AI 的資料輸入使用第 78 行到第 85 行的 `run_ai_model` 陣列進行控制
- 陣列的設定方式：對應 `sensor` 序位的內容為 `kb_run_model`，其他的皆為 `NULL`，如下圖所示
- `sensor` 序位可參考第 69 行到第 76 行的 `SensorHub::sensors` 陣列，依序為聲音、環境、加速度、磁力、壓力

```
69     Sensor *SensorHub::sensors[] =
70     {
71         &acoustic_node,
72         &bme680,
73         &kx122,
74         &gmc306,
75         &gmp102
76     };
77
78     RUN_MODEL run_ai_model[] =
79     {
80         kb_run_model,
81         NULL,
82         NULL,
83         NULL,
84         NULL
85     };
```

# AI 結果輸出

- 使用編輯器開啟 `CoreMaker-01/sensors/SensorHub.cpp`
- `SensorHub::HubTask()` 是控制 CoreMaker-01 資料輸出的主要 function
- AI 輸出控制在第 255 行到第 267 行
- 變數 `ret` 紀錄 AI 的辨識結果

```
255     else if(run_ai_model[i])
256     {
257         int ret = run_ai_model[i]((SENSOR_DATA_T*)m_dataBuffer, m_dataLen/sizeof(short), 0);
258         if (ret > -1)
259         {
260             printf("AI classification result: %d\n", ret);
261             kb_reset_model(0); // Reset running model to initial state.
262         }
263         else if (ret == -2)
264             printf("This segment has been filtered.\n");
265         else if (ret < -2)
266             printf("AI error: %d\n", ret);
267     }
```

# 外部供電(非透過USB)

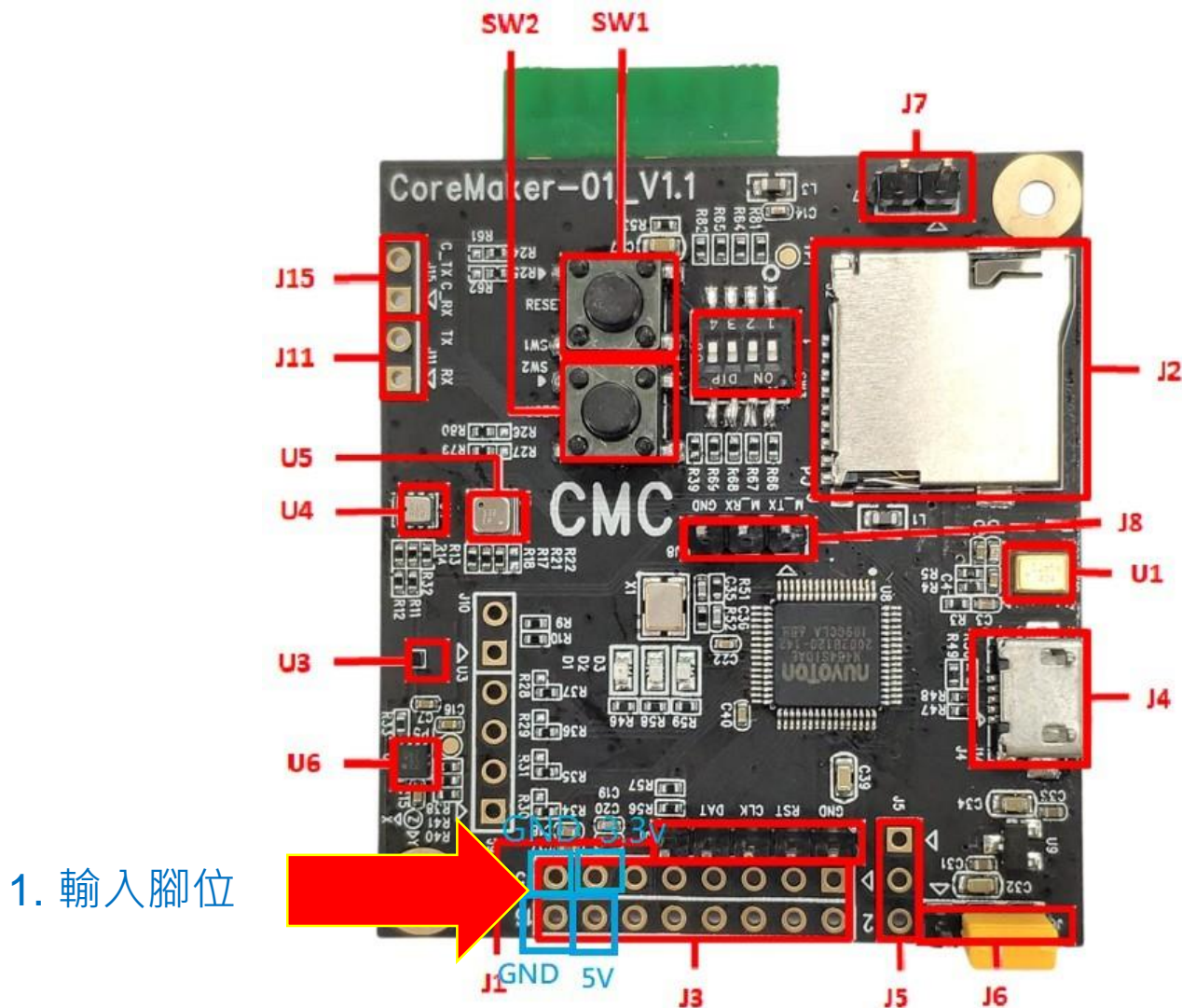

1. 輸入腳位

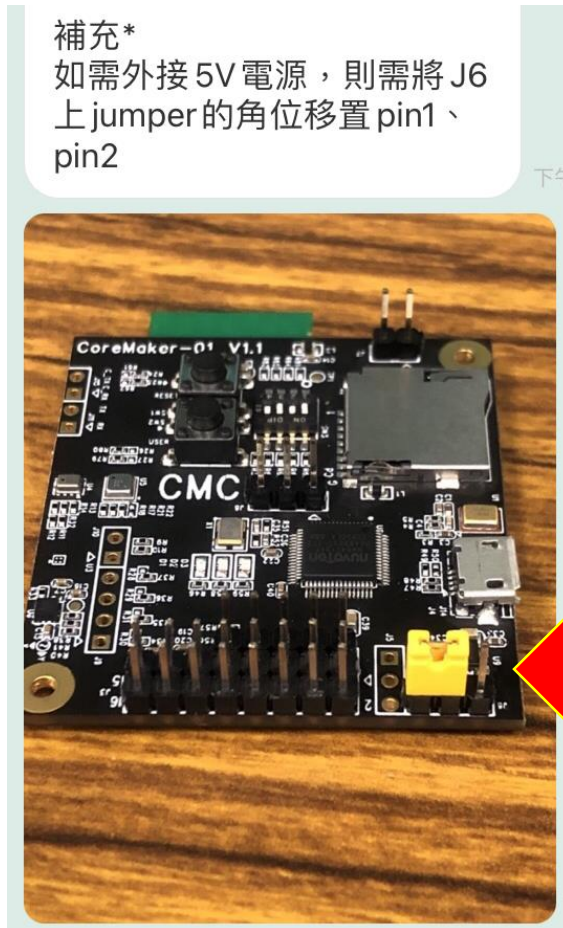

補充\*  
如需外接 5V 電源，則需將 J6 上 jumper 的角位移置 pin1、pin2

2. 修改跳線

**MEMS**  
**Coretronic**



Q & A

# 網站連結

- 中光電智能感測 (CMC): <https://www.coretronicmems.com>
- CoreMaker: <https://github.com/CoretronicMEMS/CoreMaker-01>
  - Audio Detection Demo: <https://www.youtube.com/watch?v=M3D-ABjVdil>
- 新唐M484 MCU: <https://www.nuvoton.com/products/microcontrollers/arm-cortex-m4-mcus/m484-usb-hs-otg-series/m484sidae>
- ARM Mbed OS: <https://os.mbed.com>
- 旺凌WiFi/BT:
  - 模組: [https://www.iottech-corp.com/zh-tw/iot\\_D3F1.php](https://www.iottech-corp.com/zh-tw/iot_D3F1.php)
  - SoC: <https://www.opulinks.com/products>
- SensiML: <https://sensiml.com>